**User's
Manual**

Model EY200

デジタル接地抵抗計
Digital Earth Tester

保証書付

この取扱説明書は、いつでも使用できるよう大切に
保管してください。

Store this manual in a safe place for future reference.

Introduction

Thank you for purchasing our Clamp-on Process Meter.

The following manuals, including this one, are provided as manuals for the EY200.

Read them along with this manual.

IM EY200-EN	This manual
IM CROHS-EY200	Document for China
IM EY200-93Z2	Document for Korea

Contact information of Yokogawa offices worldwide is provided on the following sheet.

PIM 113-01Z2 Inquiries (List of worldwide contacts)

Contents

Introduction	21
1. Safety Precautions	23
2. Features	26
3. Specifications	27
4. Components	30
5. Preparation for Measurement	31
5-1 Battery Voltage Check	31
5-2 Connecting Test Probes	31
6. Operating Instructions	31
6-1 Principle of Measurement	31
6-2 Precise Measurement	32
6-3 Simplified Measurement	33
7. Battery Replacement	36
8. Notes on Housing Case & Accessories	37
8-1 Case Lid	37
8-2 How to Fit Strap Belt	37
9. Before Sending for Service / Calibration cycle	38
10. Sales in Each Country or Region	39

1. Safety Precautions

This product is designed to be used by a person with specialized knowledge.

When operating the instrument, be sure to observe the cautionary notes given below to ensure correct and safe use of the instrument. If you use the instrument in any way other than as instructed in this manual, the instrument's protective measures may be impaired.

This manual is an essential part of the product; keep it a safe place for future reference.

YOKOGAWA is by no means liable for any damage resulting from use of the instrument in contradiction to these cautionary notes.

 **WARNING** Indicates a hazard that may result in the loss of life or serious injury of the user unless the described instruction is abided by.

 **CAUTION** Indicates a hazard that may result in an injury to the user and/or physical damage to the product or other equipment unless the described instruction is abided by.

The following safety symbols are used on the instrument and in this manual.

 **Danger! Handle with Care.**
This symbol indicates that the operator must refer to an explanation in the User's Manual in order to avoid risk of injury or death of personnel or damage to the instrument.

 **Double Insulation**
This symbol indicates double insulation.

 **Earth TERMINAL**
This symbol indicates ground.

Measurement Category

⚠ WARNING

The instrument is designed for measurement category III.
Do not use the instrument for measurements in locations falling that fall under measurement category IV.

Measurement category	Description	Remarks
O (None, Other)	Other circuits that are not directly connect to MEAINS.	Circuits not connected to a mains power source.
CAT II	For measurement preformed on circuits directly connected to the low-voltage installation.	Appliances, portable equipment, etc.
CAT III	For measurement preformed in the building installation.	Distribution board, circuit breaker, etc.
CAT IV	For measurement preformed at the source of the low-voltage installation.	Overhead wire, cable systems, etc.

⚠ WARNING

- Do not use the test leads (98074) for voltages exceeding 33 Vrms, 46 VAC peak or 70 VDC.
 - When measuring "earth voltage" , use the 2P test leads (98075) and the safety alligator clips (CAT III). The 2P test leads when used together with the test probe fall under category II.
 - Do not use the test leads when the test probes or the safety alligator clips are loose.
Do not use the test leads without the test probes or the safety alligator clips.
-

⚠ WARNING

- This instrument is a earth tester that can measure earth resistance (earth voltage).
Do not use this instrument for other purpose.
- Do not use the instrument if there is a problem with its physical appearance.
- Use the test leads supplied by YOKOGAWA with this instrument.
- Make sure that the range selector switch is set to a desired position before making measurement.
- Do not make measurement in the presence of flammable gasses. Otherwise, the use of the may cause sparking, which leads to an explosion.
- Never attempt to connect the test probe if the instrument or your hand is wet.
- Do not apply an electrical quantity exceeding the allowable limit of a measuring range.
- Never open the battery compartment cover while making measurement.
- Never attempt to make measurement, if any abnormal conditions are noted, such as broken case, cracked test probe and exposed metal parts.
- Never turn the range selector switch with test probe connected to the equipment under test.
- Do not replace batteries when the surface of the instrument is wet.
- Always set the range switch to the OFF position before opening the battery compartment cover for battery replacement.
- Only Yokogawa service personnel are authorized to remove the casing or disassemble or modify the instrument. Do not attempt to repair the instrument yourself, as doing so is extremely dangerous. When the instrument needs an internal inspection or calibration, contact Yokogawa or the dealer from whom you purchased the instrument.

⚠ CAUTION

The instrument is for domestic use (Class B) and meets the electromagnetic compatibility requirements.

⚠ CAUTION

- Make sure that the test probes are securely connected to the terminal of the instrument.
- Be sure to set the range selector switch to the OFF position after use.

When the instrument will not be in use for a long period of time, place it in storage after removing the batteries.

- Do not expose the instrument to the direct sun, extreme temperature and humidity or dew fall.
- Use a damp cloth soaked in water or neutral detergent for cleaning the instrument.

Do not use abrasives or solvents.

- When the instrument is wet, make sure to let it dry before putting it in storage.
-

2. Features

Model EY200 is an earth resistance tester for testing power distribution lines, in-house wiring system, electrical appliances etc. It also has an earth voltage range for earth voltage measurement.

- Designed to safety standard IEC 61557.
- Reference to IEC 60529: Degrees of protection provided by enclosures (IP54).
Measurement can be made even under adverse weather conditions.
- Large, easy-to-read LCD digital display.
- 2P Test leads (for simplified measurement) has a structure that both the Safety alligator clip and the Test probe are available.
- Warns when earth resistance of auxiliary earth spikes exceeds the permissible limit.
- Convenient carrying soft bag for accessories etc.

3. Specifications

Measuring Range and Accuracy

(at $23 \pm 5^{\circ}\text{C}$, RH 75% or less)

Range	Measuring Range	Accuracy	
Earth voltage	$\sim V^*$	0 to 199.9 V	$\pm(1.0\% \text{ rdg} + 4 \text{ dgt})$
Earth Resistance	20 Ω	0 to 19.99 Ω	$\pm(2.0\% \text{ rdg} + 0.1\Omega)$ (0 to 19.99 Ω)
	200 Ω	0 to 199.9 Ω	$\pm(2.0\% \text{ rdg} + 3 \text{ dgt})$ (20 Ω or more)
	2000 Ω	0 to 1999 Ω	(Auxiliary earth resistance 100 Ω $\pm 5\%$)

* $\sim V$ Range = Earth voltage (Series interference voltage)

EMC Standards

EN 61326-1 Class B, EN 61326-2-2,

EN 55011 Class B Group 1

EMC Regulatory Arrangement in Australia and New Zealand

Korea Electromagnetic Conformity Standard

(한국 전자파적합성기준)

RF field strength = $\leq 1\text{V/m}$, total accuracy: specified accuracy

RF field strength = 3V/m , total accuracy: specified accuracy
+5% of range

Safety Standards

EN 61010-1, EN 61010-2-030

Measurement category III (CAT III) 300 V

Indoor use, Altitude 2000 m or less, Pollution degree 2

EN 61010-031

Standards

Compliant with EN 61557-1, EN 61557-5, IEC 60529 (IP54)

Environmental standard

EN 50581

Monitoring and control instruments including industrial monitoring and control instruments

Measuring Method

Earth voltage measurement*

Mean value

Earth resistance measurement

Constant current inverter

Measuring current: Approx. AC 3mA (at 20 Ω range)

Frequency: Approx. 820Hz

Maximum Operating Error

Operating error (B) is an error obtained within the rated operating conditions, and calculated with the intrinsic error (A), which is an error of the instrument used, and the error (E_i) due to variations.

$$B = \pm (| A | + 1.15 \times (E_1^2 + E_2^2 + E_3^2 + E_4^2 + E_5^2 + E_7^2 + E_8^2))$$

A : Intrinsic error

E₁ : Variation due to changing the position

E₂ : Variation due to changing the supply voltage

E₃ : Variation due to changing the temperature

E₄ : Variation due to series interference voltage

E₅ : Variation due to resistance of the probes and auxiliary earth electrode resistance

E₇ : Variation due to changing the system frequency

E₈ : Variation due to changing the system voltage

Range to keep the maximum operating error

Measurement range within which the maximum operating error ($\pm 30\%$) applies.

20 Ω range : 5 to 19.99 Ω

200 Ω range : 20 to 199.9 Ω

2000 Ω range : 200 to 1999 Ω

Battery life

Number of measurement: 3300 times or more (Measure 10 Ω for 5sec on 20 Ω range and take a pause for 25sec/ using manganese batteries)

Operating Temperature and Humidity

0 to 40°C , relative humidity 85% or less (no condensation)

Storage Temperature and Humidity

-20 to 60°C , relative humidity 75% or less (no condensation)

Power Source

9V DC: Six (6) 1.5 V manganese batteries (R6P, AA-size) or

Six (6) 1.5 V alkaline batteries (LR6, AA-size)

Overload Protection

Earth voltage ranges: 300V AC (1 minute)

Earth resistance ranges : 280V AC (10 seconds) (between E and P, E and C terminals)

Insulation Resistance

5M Ω or more at 500V between the electrical circuit and the housing case

Dielectric Strength (Withstand Voltage)

3700V AC for one minute between the electrical circuit and the housing case

Dimensions

Approx. 105(L) × 158(W) × 70(D) mm

Weight

Approx. 550g (including batteries)

Accessories

Product Name	Model No.	Quantity
Test Leads (Red 20m, Yellow 10m, Green 5m)	98074	1 set
Auxiliary Earth Spikes	98070	2
2P Test Leads (Red, Black/Green)	98075	1 set
Soft Case	93041	1
Shoulder Strap (for EY200)	99018	1
User's Manual (Japanese/English)		1
Batteries R6P		6

*Name Plate in English (Part No.L4058EA)

4. Components

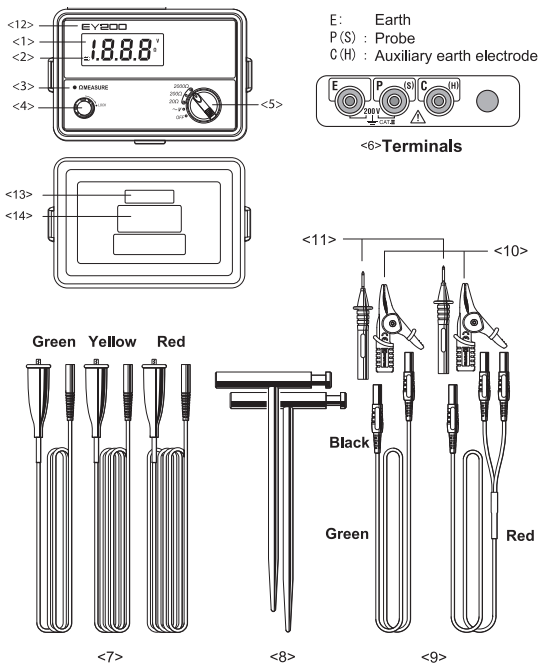

- < 1> LCD Display
- < 2> Battery Replacement Mark (Low Battery)
- < 3> Indication LED With Measurement
- < 4> Press To Test Button (Ω MEASURE)
- < 5> Range Selector Switch
- < 6> Measuring Terminals
- < 7> Test Leads
- < 8> Earth Spikes
- < 9> 2P Test Lead
- < 10> Safety Alligator Clip
- < 11> Test Probe
- < 12> Model
- < 13> Serial number
- < 14> Name plate

5. Preparation for Measurement

5-1 Battery Voltage Check

Turn on (set \bar{V} position) the instrument. If the display is clear without low battery symbol showing, battery voltage is sufficient. If the display blanks or is low battery symbol indicated, replace the batteries according to section 7 for Battery Replacement.

Low battery symbol : 

5-2 Connecting Test Leads

Insert the plug of the Test Leads securely into the terminals of the instrument.

Loose connection may result in inaccurate measurements.

<Note>

“Plug caps” are attached to Test Leads at shipment.

(Please remove and keep the Plug caps when connecting.)

6. Operating Instructions

WARNING

- The instrument will produce a maximum voltage of about 50V between terminals E-C in earth resistance function. Take enough caution to avoid electric shock hazard.
 - When measuring earth voltage, do not apply voltage greater than 200V between measuring terminals.
 - When measuring earth resistance, do not apply voltage between measuring terminals.
-
-

CAUTION

To verify the instrument's functionality, check that the measured value is update after turning on the power. If the measured value is not update, the reading will be incorrect and may lead to possible electrical shock or personal injury.

6-1 Principle of Measurement

This instrument makes earth resistance measurement with fall-of-potential method, which is a method to obtain earth resistance value R_x by applying AC constant current I between the measurement object E (earth electrode) and C (current

electrode), and finding out the potential difference V between E and P (potential electrode).

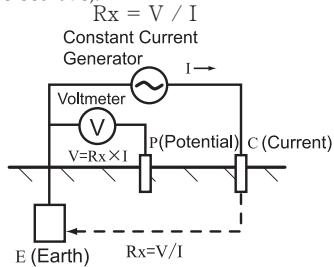

6-2 Precise Measurement (Using Test Leads)

<1> Test probe connection

Stick the auxiliary earth spikes P and C into the ground deeply. They should be aligned at an interval of 5 to 10m from the earthed equipment under test.

Connect the green wire to the earthed equipment under test, the yellow wire to the auxiliary earth spike P and the red wire to the auxiliary earth spike C from terminals E , P and C of the instrument in order. (three-probe (wire) method)

<Note>

- Make sure to stick the auxiliary earth spikes in the moist part of the soil.
Give enough water where the spikes have to be stuck into the dry, stony or sandy part of the earth so that it may become moist.
- In case of concrete, lay the auxiliary earth spike down and water it, or put a wet dust cloth etc. on the spike when making measurement.

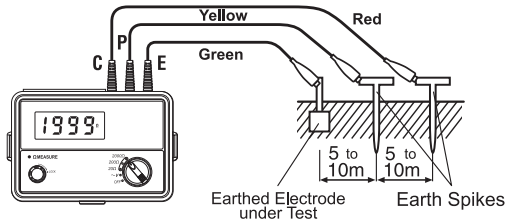

<2> **Earth Voltage Measurement (Series interference voltage): ~V**
Set the range switch to Earth voltage (V) position in the condition of <1>.

Earth voltage will be indicated on the display. Make sure that the voltage is 3V or less.

When the display reads more than 3V, it may result in excessive errors in earth resistance measurement. To avoid this, make measurement after reducing the voltage by turning off the power supply of the equipment under test etc.

<3> **Earth resistance (Ω) Measurement: (Precise Measurement)**

Set the range switch to 2000 Ω position and press the test button (Ω measurement).

LED remains illuminated during testing. Turn the range switch to 200 Ω and 20 Ω when the earth resistance is low. This indicated value is the earth resistance of the earthed equipment under test.

<Note>

- If the auxiliary earth resistance of auxiliary earth spike C is too high to make measurement, the display reads ' . . . '. Recheck the connection of test leads and the earth resistance of auxiliary earth spike.

⚠ CAUTION

- If measurement is made with the probes twisted or in touch with each other, the reading of the instrument may be affected by induction. When connecting the probes, make sure that they are separated.
- If earth resistance of auxiliary earth spikes is too large, it may result in inaccurate measurement.

Make sure to stick the auxiliary earth spike P and C into the moist part of the earth carefully, and ensure sufficient connections between the respective connections.

6-3 Simplified Measurement (Using 2P Test Leads)

Use this method when the earth spike cannot be stuck. In this method, an existing earth electrode with a low earth resistance, such as a metal water pipe, a common earth of a commercial power supply and an earth terminal of a building, can be used with two-pole (wire) method (E,P).

Use the simplified measurement probe attached which has a convenient structure that both the safety alligator clip and the test bar are available.

<1> Wiring

Make connection as shown in the following figure.

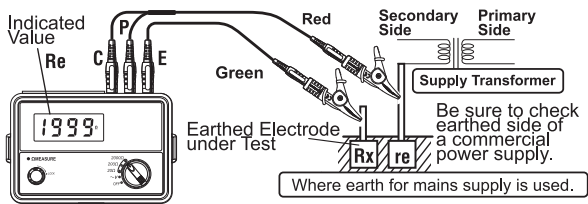

<Note>

- When the 2P Test Leads are not used, short P and C terminals.

⚠ WARNING

- Please be sure to use a voltage detector to check a common earth of commercial power supply.
- Do not use the instrument to check a common earth of commercial power supply.

A danger will be caused because the voltage may not be displayed even in case of a live conductor when the connection of the earth electrode to be measured has come off, or when the connection of the test leads of the instrument is not correct etc.

- Do not use the instrument to measure the voltage of commercial power supply.

The instrument is not designed for voltage measurement of commercial power supply.

When using the 2P Test Leads, P and C terminals will be short-circuited and the input impedance will be reduced. The residual current circuit breaker may operate when making measurement of the voltage in the circuit with the breaker.

<2> Earth Voltage Measurement (Series interference voltage): ~V
Set the range switch to Earth voltage (V) position in the condition of <1>.

Earth voltage will be indicated on the display. Make sure that the voltage is 3V or less.

When the display reads more than 3V, it may result in excessive errors in earth resistance measurement. To avoid this, make measurement after reducing the voltage by turning off the power supply of the equipment under test etc.

<3> Earth resistance (Ω) Measurement: Simplified Measurement
Set the range switch to 2000 Ω position and press the test button (Ω measurement).

LED remains illuminated during testing. Turn the range switch to 200 Ω and 20 Ω when the earth resistance is low. This indicated value is the earth resistance of the earthed equipment under test.

<Note>

- If the auxiliary earth resistance of auxiliary earth spike C is too high to make measurement, the display reads ' . . . '. Recheck the connection of test leads and the earth resistance of auxiliary earth spike.

<4> Simplified Measurement Value

Two-pole(wire) method is used for simplified measurement. In this method, earth resistance value r_e of earth electrode connected to terminal P is added to true earth resistance value R_x and shown as an indicated value R_e .

$$R_e = R_x + r_e$$

If the r_e is known beforehand, true earth resistance value R_x is calculated as follows.

$$R_x = R_e - r_e$$

7. Battery Replacement

⚠ WARNING

- Never attempt to open the battery compartment cover, if the outer surface of the instrument is wet.
- Never attempt to replace batteries while making measurement. To avoid shock hazard, turn the instrument off and disconnect the test leads and the probes from the instrument before opening the battery compartment cover.

⚠ CAUTION

- Do not mix new and old batteries.
- Install batteries in the orientation as shown inside the battery compartment, observing correct polarity.

Six (6) 1.5 V manganese batteries (R6P, AA-size) or

Six (6) 1.5 V alkaline batteries (LR6, AA-size)

<Replacement procedure>

- <1> Turn off the instrument and disconnect the Test Leads from the terminals.
- <2> Loosen two screws on the bottom of the instrument and remove the battery cover.
- <3> Always replace all six batteries in correct polarity.
- <4> Put the cover back in place and tighten the two screws.

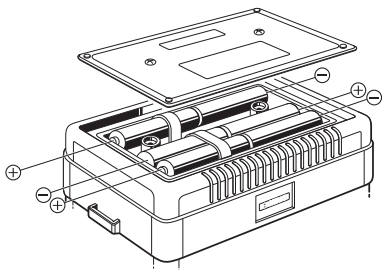

8. Notes on Housing Case & Accessories

8-1 Case Lid

Case lid can be fit under the housing case while making measurement.

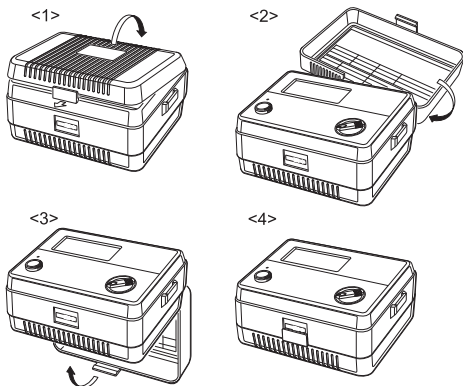

8-2 How to Fit Strap Belt

The instrument is equipped with a Shoulder strap to suspend from the neck to allow both hands to be used freely for easy and safe operation.

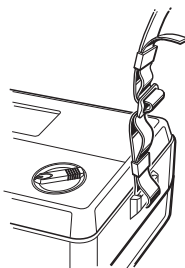

9. Before Sending for Service / Calibration cycle

If the instrument does not operate normally, please contact nearby Yokogawa sales office.

Before returning the instrument follow the trouble-shooting guide shown below.

If the instrument does not turn on;

Check whether batteries are missing or they are installed incorrect polarity.

(For details of battery, see 7.Battery Replacement)

Note that batteries were not installed in the instrument at shipment.

If the display reads '1 . . . ' in earth voltage measurement;

A voltage exceeding 200V is being applied to the instrument.

Halt the measurement immediately, otherwise the instrument may be damaged.

⚠ WARNING

- When measuring earth voltage, do not apply voltage greater than 200V between measuring terminals.
-

If the display reads ' . . . ' in precise earth resistance measurement;

Stick the auxiliary earth spikes deeper into the earth, or stick them at other locations; or Add moisture to the part of the earth where C auxiliary earth spike is stuck (connected with the red wire); and Short the three test leads and check if the display indicates a value near ' 0.00 '.

(For details of measuring, see 6-2 Precise Measurement)

If the display reads ' . . . ' in simplified earth resistance measurement;

Check if the connection to a metal water pipes, a common earth of commercial power supply, etc., is secure; or

Use another metal water pipe, common earth of commercial power supply, etc.

(For details of measuring, see 6-3 Simplified Measurement)

Calibration cycle

It is recommended that the tester be calibrated once every year for correct operation.

10. Sales in Each Country or Region

Disposing the Product

Waste Electrical and Electronic Equipment (WEEE), Directive

(This directive is valid only in the EU.)

This product complies with the WEEE directive marking requirement. This marking indicates that you must not discard this electrical/electronic product in domestic household waste.

Product Category

With reference to the equipment types in the WEEE directive, this product is classified as a “Monitoring and Control instruments” product.

When disposing products in the EU, contact your local Yokogawa Europe B.V. office.

Do not dispose in domestic household waste.



How to Replace and Dispose the Batteries

EU Battery Directive

(This directive is valid only in the EU.) Batteries are included in this product.

When you remove batteries from this product and dispose them, discard them in accordance with domestic law concerning disposal.

Take a right action on waste batteries, because the collection system in the EU on waste batteries are regulated.



Battery type: Manganese dry cell

Criterion value (weight percent): Lead (Pb) 0.004%

Pb

Notice:

This marking indicates they shall be sorted out and collected as ordained in the EU battery directive.

The chemical symbol beneath the marking means relevant chemical substance is contained more than criterion value in battery.

How to remove batteries safely:

For further details, see "7 Battery Replacement".

Authorized Representative in the EEA

Authorized Representative in the EEA Yokogawa Europe B.V. is the authorized representative of Yokogawa Test & Measurement Corporation for this product in the EEA.

(EEA: European Economic Area)

To contact Yokogawa Europe B.V., see the separate list of worldwide contacts, PIM 113-01Z2.

