



# MAGNETROL®

## Model R82 Pulse Burst Radar Level Transmitter

### DESCRIPTION

The Magnetrol® Model R82 is an economical, loop-powered radar transmitter bringing radar to everyday applications. Applications that have been considered for ultrasonic can now utilize the superior performance of radar technology. The electronics are housed in a compact, single compartment cast aluminum or Lexan® housing. The R82 measures effectively even when atmospheres above the liquid are saturated with vapor. Pulse Burst technology and advanced signal processing manage common disturbances such as false echoes caused by obstructions, multi-path reflections from tank sidewalls or turbulence caused by agitators, aggressive chemicals, or aerators.

### TECHNOLOGY

Model R82 Pulse Burst Radar emits short bursts of 26 GHz energy. High-speed timing circuitry measures the time of the signal reflected off the liquid surface. Sophisticated signal processing filters out false reflections and other background noises. The exact level is then calculated by factoring tank height and sensor offset information. The Model R82 circuitry is extremely energy efficient so duty cycling is not needed as it is with other radar products. This allows tracking of high rates of level change up to 180"/min (4.5m/min).

### APPLICATIONS

**MEDIA:** Liquids and slurries; hydrocarbons to water based media (dielectric 1.7–100).

**VESSELS:** Most effective in storage vessels up to rated temperature and pressure. Pits and sumps, metallic and non-metallic tanks, others including plastic, glass-lined and concrete.

**CONDITIONS:** Virtually all level measurement and control applications including process conditions exhibiting varying specific gravity and dielectric, visible vapors, high fill/empty rates and some turbulence.

**MARKETS:** All process markets including replacement of loop-powered, ultrasonic transmitters.



### FEATURES

- 24 VDC, loop-powered transmitter for level, volume, and open channel flow measurement
- 26 GHz frequency
- Configure with 2-line x 16-character display, 4-push-button keypad and PACTware™ PC Program (see bulletin 59-101)
- Range: 15" to 40 feet (0.4 to 12.2 m)
- Ambient: -40 to +175 °F (-40 to +80 °C)
- Process
  - Temperature: -40 to +200 °F (-40 to +93 °C)
  - Pressure: Vacuum to 200 psig (13.8 bar)
  - Dielectric: 1.7–100
- Performs to ±0.2" (5 mm) or 0.05% of tank height
- Lexan® EXL or Cast Aluminum housings
- Antenna horn encapsulated with Polypropylene, ETFE (optional)
- Antenna extensions of 2" (50 mm) and 8" (200 mm)
- 2" NPT or BSP connections (Sch. 40 maximum)
- Adjustable beam pattern without removing transmitter from vessel
- Antenna output of <.01 mW (avg), <2 mW (max)
- Safety Integrity Level (SIL) value of 1 (SFF 89.1%)
- Common tank shapes and 20-point custom table for fast and accurate volume configuration
- Generic Discharge Flow Equation and 35 flume/weir primary elements for open channel flow applications
- Two 7-digit flow totalizers, one resettable, and one non-resettable

# LEVEL APPLICATIONS

## PULSE BURST RADAR

### STORAGE AND INTERMEDIATE HOLDING TANKS

CONDITIONS – Calm Surfaces

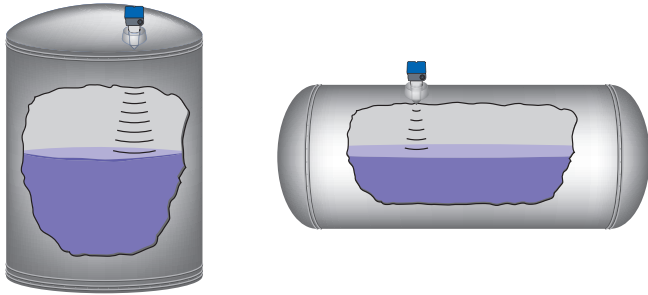

### STANDPIPES AND CHAMBERS (2" ONLY)

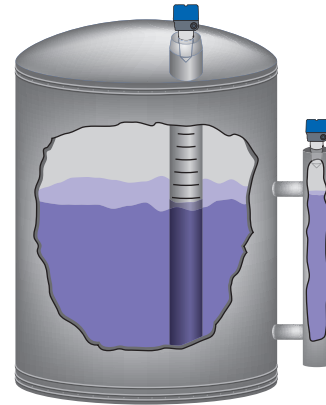

### MIXING AND BLENDING VESSELS

CONDITIONS – Moderate Turbulence and Changing Dielectric

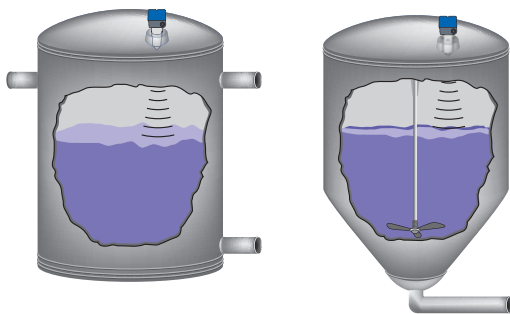

### ENCLOSED SUMPS

CONDITIONS – Turbulence and Changing Dielectric

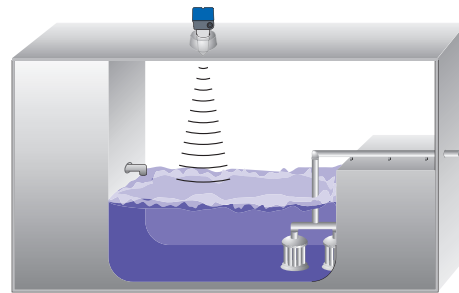

# OPEN CHANNEL FLOW APPLICATIONS

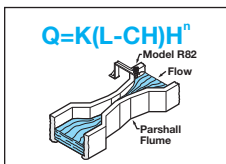

### Extensive Selection of Primary Flow Elements

With a total of 35 flume and weir curves stored in the electronics, it would be difficult to find an open channel flow application that cannot be handled by the R82 transmitter. Unusual flow applications can readily be accomplished through the use of either the 20-point Custom Table or the Generic Discharge Flow Equation which allows a direct entry of unique flow equations.



### Dual Flow Totalizers

Two 7-digit flow totalizers are provided for recording flow in cubic feet, gallons, million gallons, liters, million liters, or cubic meters. One totalizer is resettable and the other is non-resettable. Several multipliers are selectable to allow for proper scaling. Totalizer time is also recorded to show how long each totalizer has been recording flow.

### ENCLOSED FLUMES AND WEIRS

CONDITIONS – Turbulence and Changing Dielectric

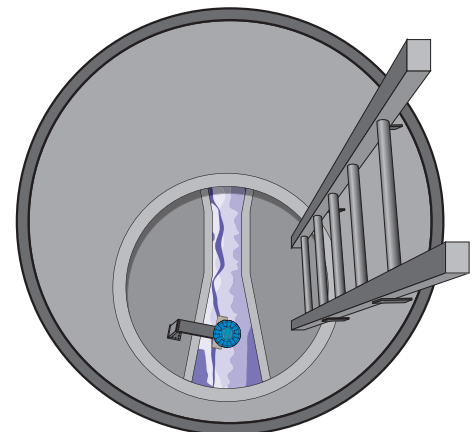

NOTE: For optimal accuracy, mount the transmitter a minimum of 30" above the flow element (this is dependent on type and size of the flow element). Consult factory for assistance on this dimension.

# TECHNOLOGY

## PULSE BURST RADAR

The R82 transmitter is a top-mounted, downward-facing pulse burst radar operating at 26 GHz. The R82 emits short bursts of 26 GHz energy (Figure 1) and measures the transit time of the signal reflected off the liquid surface.

Distance is calculated utilizing the equation: Distance equals the Speed of light multiplied by the transit time divided by two ( $Distance = C \times Transit\ Time / 2$ ), then developing the level value by factoring in tank height and sensor offset information (Figure 2). The reference point for distance and level calculations is the sensor reference point (bottom of an NPT thread, top of a BSP thread, or face of a flange).

The exact level measurement is extracted from false target reflections and other background noise via the use of

sophisticated signal processing. The R82 circuitry is extremely energy efficient so no duty cycling is necessary to accomplish effective, measurement. For this reason it can track high rates of change (180 inches [450 cm] per minute) that have been impossible with existing loop-powered radar transmitters.

By inputting the type and geometry of a vessel, the electronics can also calculate the liquid volume in the vessel. In a similar operation, the Model R82 can perform open channel flow measurement by converting the level reading into units of volume per time. Common tank shapes, flumes and weirs are stored in the R82 software. A 20-point custom table is also available for unusual tanks or primary flow elements.

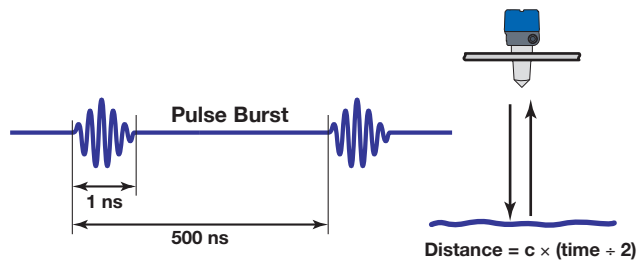

Figure 1

## OPERATIONAL CONSIDERATIONS

Radar applications are characterized by three basic conditions:

- Dielectric
- Distance (measuring range)
- Disturbances (turbulence, foam, false targets, multiple reflections and rate of change)

The R82 Radar transmitter is offered with two basic antenna configurations:

- Polypropylene-encapsulated horn
- ETFE-encapsulated horn

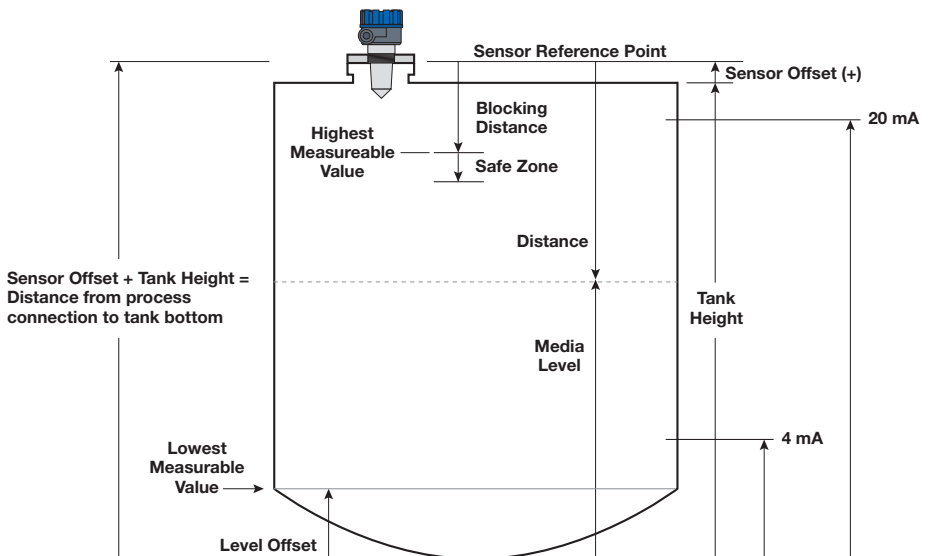

Figure 2

# OPERATIONAL CONSIDERATIONS (cont.)

Maximum measuring range (distance) is calculated as Tank Height + Sensor Offset. Refer to Figure 2 on page 3. It is measured from the sensor reference point (bottom of NPT thread, top of BSP thread, or face of flange). The Maximum Distance chart shows the maximum measuring range of each antenna based on dielectric and turbulence.

**MAXIMUM DISTANCE** feet (meters)

Dielectric	Turbulence	R82
1.7-3.0	None	26 (8.0)
	Light, < 0.5"	21 (6.4)
	Moderate, < 1.0"	14 (4.3)
	Heavy, > 1.0"	7 (2.1)
3.0-10.0	None	33 (10.1)
	Light, < 0.5"	26 (7.9)
	Moderate, < 1.0"	19 (5.8)
	Heavy, > 1.0"	12 (3.7)
10.0-100	None	40 (12)
	Light, < 0.5"	32 (9.8)
	Moderate, < 1.0"	24 (7.3)
	Heavy, > 1.0"	17 (5.2)

## MOUNTING

The R82 Radar transmitter can be mounted on to a vessel using a variety of process connections. Generally either a threaded or flanged connection is used.

### LOCATION

Ideally, the radar transmitter should be mounted  $\frac{1}{2}$  radius from center, providing an unobstructed signal path to the liquid surface where it should illuminate (with microwave energy) the largest possible surface area. Do not install in center of tank top or within 10 inches (25 cm) of tank wall. Tank walls may produce reflections that must be minimized during field configuration (Orientation). Refer to Figure 3 & 4.

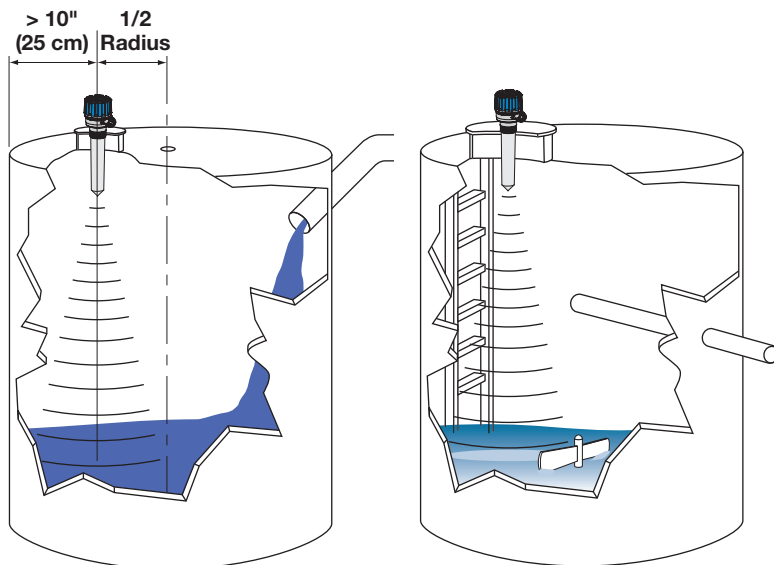

Figure 3

Figure 4

### BEAM ANGLE

Figure 5 shows the beam angle for the R82 antennas. Ideally, the beam pattern should illuminate the maximum liquid surface with a minimum of striking other objects in the vessel including the tank wall. Use these drawings to determine the optimum installation location.

### OBSTRUCTIONS

Almost any object that falls within the beam pattern will cause reflections that may be misinterpreted as a false liquid level. Although the R82 has a powerful Echo Rejection routine, all possible precautions should be taken to minimize false target reflections with proper installation and orientation. Refer to Figures 4 & 5.

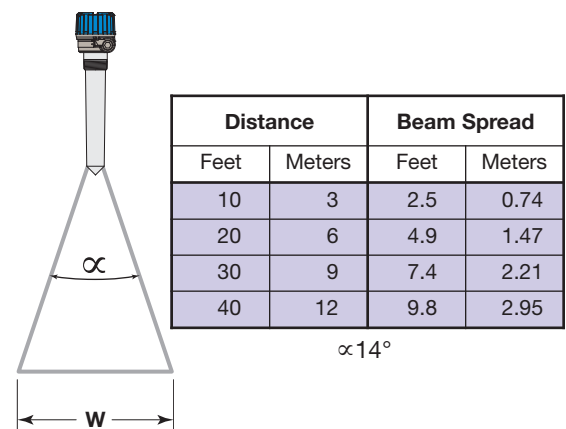

Figure 5

# MOUNTING

## NOZZLES

Improper installation in a nozzle can create “ringing” which may adversely affect measurement. Ideally, the antenna should be mounted so the end of the antenna is a minimum of 0.5" (12 mm) below the nozzle (be sure to include any nozzle dimension *inside* the vessel). Two antenna extension lengths (2" or 8") are offered to allow the R82 transmitter to work reliably in a variety of nozzles.

The Minimum Blocking Distance of 15" (380 mm), BSP: 16" (405 mm) is always measured from the bottom of the threads or face of a flange. The related distance (as measured from the end of the antenna) varies depending on the antenna extension chosen. Refer to Figure 6.

When necessary, the narrow beam width of the 26 GHz R82 does allow mounting so that the antenna is recessed inside the nozzle. Optimally, the recessed dimension should never exceed 2x the nozzle diameter (Sch. 40 maximum). Refer to Figure 7.

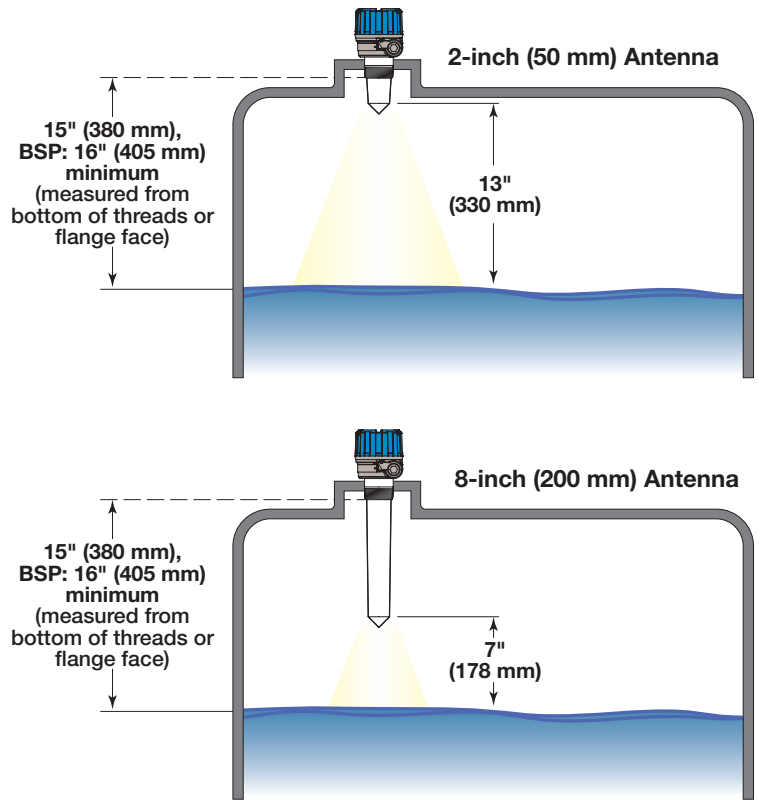

Figure 6  
Minimum Blocking Distance

**Maximum Recess ( $m$ ) is  $2 \times$  Nozzle Diameter ( $d$ ) (Sch. 40 maximum)**

example: 2" diameter nozzle

example: 4" diameter nozzle

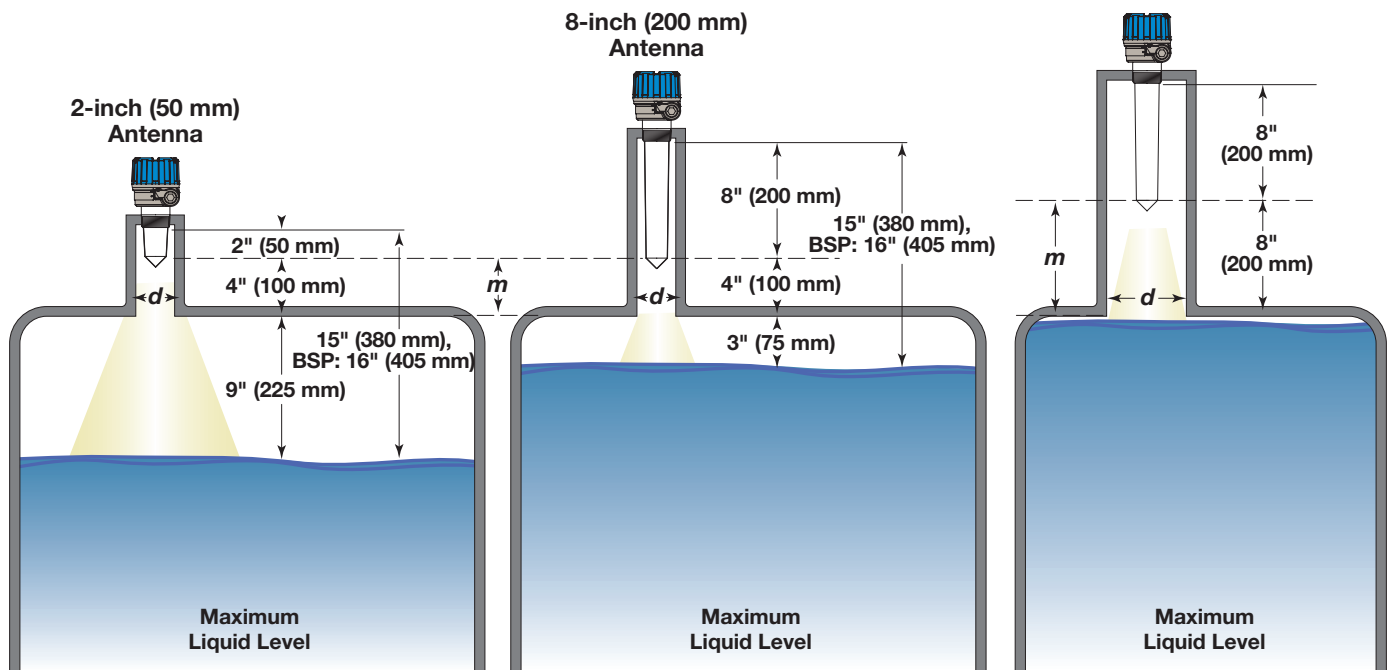
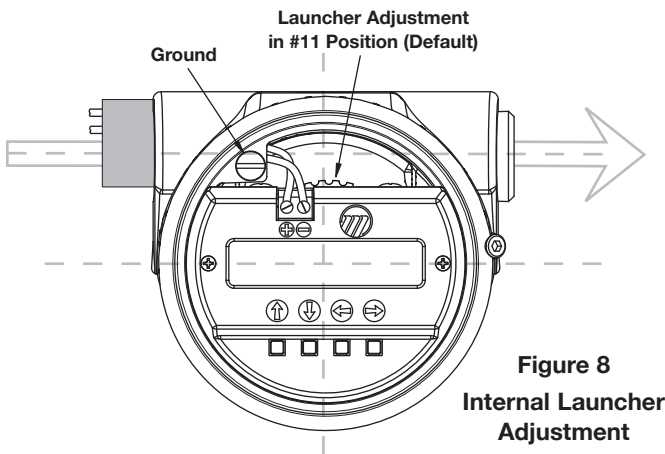

Figure 7  
Maximizing Useable Capacity

## ORIENTATION

The R82 transmitter utilizes a linearly polarized, microwave beam that can be rotated to improve its performance. Proper orientation can minimize unwanted target reflections, decrease sidewall reflections (multipath) and maximize direct reflections from the liquid surface. The polarization pattern is parallel to the transmitter display when the mechanism is at the #11 position. Refer to Figure 8. Each index number represents 10 degrees of rotation.



**Figure 8**  
Internal Launcher Adjustment

In a typical vertical tank, the Launcher should be adjusted so the polarization pattern is parallel to a line tangent to the nearest tank wall. Refer to Figure 9.

For horizontal cylindrical vessels, direct the beam down the long axis of the vessel.

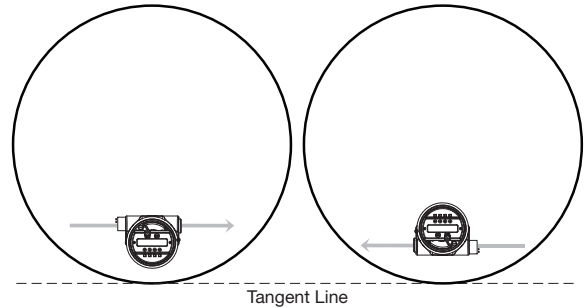
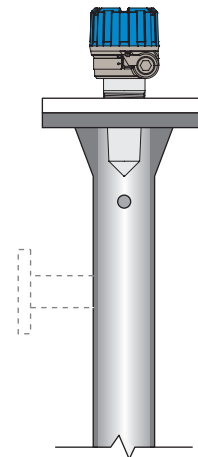

**Figure 9**  
Launcher Orientation

## STANDPIPES, STILLWELLS AND BRIDLES

The R82 can be mounted in a standpipe or stillwell but certain considerations should be given:

- Metal stillwells only: 2" (50 mm), Sch. 40 maximum.
- Diameter must be consistent throughout length; no reducers.
- Stillwell length must cover complete range of measurement (i.e., liquid must be in stillwell).
- Welds should be smooth.
- Vents: holes <0.125" diameter, slots <0.125" width.
- If an isolation valve is used, it must be a full-port ball valve with an I.D. equal to the pipe diameter.
- Bridles/Bypass Installations: The launcher adjustment (#9 position, default) should be rotated 90° from process connections.
- Configuration must include an entry for PIPE I.D.



**Figure 10**  
Use in Standpipe/Stillwell

## PROBLEMATIC APPLICATIONS

### GUIDED WAVE RADAR ALTERNATIVE

Some applications can be problematic for Pulse Burst Radar. The following are examples of when Guided Wave Radar is recommended.

- Extremely low dielectric media ( $\epsilon_r < 2.0$ ).
- Very weak reflections from the liquid surface—particularly during turbulence can cause poor performance.
- Tanks heavily cluttered with false targets (mixers, pumps, ladders, pipes, etc.).
- During times of very low liquid levels of low dielectric media, the metal tank bottom may be detected (deteriorating performance).

*(Continued on next page.)*







# PROBLEMATIC APPLICATIONS (cont.)

## GUIDED WAVE RADAR ALTERNATIVE

- Foam can either absorb or reflect the microwave energy depending upon the depth, dielectric, density and wall thickness of the bubbles. Due to typical variations in the amount (depth) of foam, it is impossible to quantify performance. It may be possible to receive most, some or none of the transmitted energy.
- Extremely high liquid level (Overflow) conditions when liquid is very near the antenna can cause erroneous readings and measurement failure.  
*Refer to Eclipse Guided Wave Radar bulletin 57-101.*

## AGENCY APPROVALS

AGENCY	MODEL	PROTECTION METHOD	AREA CLASSIFICATION
<b>United States</b> 	R82-52XA-0XX	Intrinsically Safe	Class I, Div. 1; Groups A, B, C, & D T4 @80°C; Type 4X, IP66/67 ① Entity
	R82-51XA-0XX	Non-Incendive ②	Class I, Div. 2; Groups A, B, C, & D Type 4X, IP66/67 ①
<b>Canada</b> 	R82-52XA-0XX	Intrinsically Safe	Class I, Div. 1; Groups A, B, C, & D T4 @80°C; Type 4X, IP66/67 ① Entity
	R82-51XA-0XX	Non-Incendive ②	Class I, Div. 2; Groups A, B, C, & D T4 @80°C; Type 4X, IP66/67 ①
<b>ATEX/IEC</b> 	R82-5BXA-0XX	Intrinsically Safe ③④ EN60079-0: 2006/IEC 60079-0: 2007 EN60079-11: 2007/IEC 60079-11: 2006 EN60079-26: 2007 standards applied/ IEC 60079-26: 2006	⊕ II 1G Ex ia IIC T4 @70°C Ambient Temp: -40 to +70 °C Ex ia IIC T4 Ga
<b>BRAZIL</b> 	R82-5BXA-0XX	Intrinsically Safe ③④ ABNT NBR IEC 60079-0: 2006 ABNT NBR IEC 60079-11: 2009 ABNT NBR IEC 60529: 2005	BR-Ex ia IIC T4, IP66/IP67 ① ABNT NBR IEC 60079-0: 2006 Ambient Temp: -40 to +70 °C AEX-12645-X

- ① Type 4X rating applies to aluminum housing only; IP67 rating applies to Lexan housing only.
- ② For Division 2 the measured media inside the vessel must be non-flammable only. The transmitter must be connected to an inherently limited Class 2 power source (as defined in the NEC Table 11), or as a low energy Class 2 power source (as defined in the CEC Section 16).
- Special conditions for safe use (ATEX/IEC Ex i)**
- ③ Materials marked as Category 1 equipment and mounted in hazardous areas requiring this Category shall be installed in such a way that, even in the event of rare incidents, the aluminum enclosure cannot be an ignition source due to impact or friction.
- ④ The transmitter shall be installed so that electrostatic discharges on plastic parts are prevented.

### SIL

Model R82		
SIL	1 as 1001	
Instrument Type	B	
SFF	89.1%	
PFDavg	3.34E-04	
	<b>FITS</b>	<b>Annual</b>
Fail Dangerous Undetected	68	5.96E-04
Fail Dangerous Detected	388	3.40E-03
Safe	169	1.48E-03



These units have been tested to ETSI EN 302 372-1 and ETSI EN 301 489-1 and are in compliance with the RTTE Directive 1999/5/EC. In addition these units were tested to EN 61326 and are in compliance with the EMC Directive 2004/106/EC.

### IEC/ATEX Entity Parameters

Ui	28.4 VDC	28 VDC
Ii	94 mA	120 mA
Pi	0.67 w	0.84 w
Ci	5.5 nF	
Li	370 µH	

### COMMUNICATIONS APPROVALS

Region	Agency	Frequency
US	FCC	26 GHz
Canada	IC	
Europe	RTTE	

Radar level device installed in closed plastic tanks, metallic tanks or reinforced concrete tanks.

# SPECIFICATIONS

## TRANSMITTER: FUNCTIONAL

### System Design

Measurement Principle Pulse burst radar @ 26 GHz ①

### Input

Measured Variable Level, determined by the time-of-flight of a radar pulse from transmitter to product surface and back

Span 15 inches to 40 feet (380 mm to 12.2 m) measured from threads

### Output

Type Analog: 4 to 20 mA with optional HART digital signal

Range Analog: 3.8 to 20.5 mA useable (Namur NE43)

Digital: 0 to 999" (0 to 9999 cm)

Resolution Analog: 0.01 mA

Digital: 0.1"

Loop Resistance GP/IS - 400 Ω @ 24 VDC/20 mA, 350 Ω @ 24 VDC/22 mA

Diagnostic Alarm Adjustable 3.6 mA, 22 mA, HOLD

Damping Adjustable 0–45

Output at Antenna < .01 mW (avg), < 2 mW (max)

### User Interface

Keypad 4-button menu-driven data entry and system security

Indication 2-line × 16-character display

Digital Communication HART Version 5 compatible

### Power (Measured at instrument terminals)

General Purpose/Intrinsically Safe 16 to 36 VDC

### Housing

Material Lexan® base and cover

Cast Aluminum A356T6 (<0.2% copper)

Cable Entry ¾" NPT, M20

Ingress Protection Lexan Housing: NEMA 6P (IP67/68) ②

Aluminum Housing: NEMA 4X/6P (IP67/68) ②

Net/Gross Weight Short Lexan: 23 oz.

Long Lexan: 32 oz.

Short Aluminum: 49 oz.

Long Aluminum: 58 oz.

Overall Dimensions Lexan: Refer to drawings on page 11

Aluminum: Refer to drawings on page 11

① RTTE: European approval,  
FCC & IC: North American approval

② Installation for NEMA 6P/IP 68:  
the transmitter can be installed to  
allow for temporary submergence  
to 6.5 ft. (2 m) for 24 hours

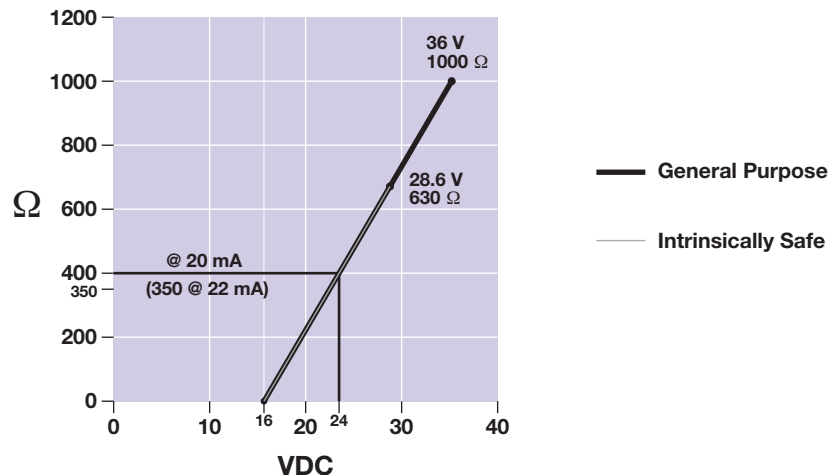



# SPECIFICATIONS

## TRANSMITTER: FUNCTIONAL (CONT.)

<b>Antenna</b>	
Encapsulated Horn	Polypropylene, ETFE (optional) -40 to +200 °F @atmos (-40 to +93 °C) Vacuum to 200 psig @ +70 °F (-1 to 13.8 bar) ETFE
Wetted Surfaces	Polypropylene or ETFE (optional)
<b>Environment</b>	
Operating Temperature	-40 to +175 °F (-40 to +80 °C)
LCD	-5 to +160 °F (-20 to +70 °C)
Storage Temperature	-50 to +175 °F (-46 to +80 °C)
Humidity	0-99%, non-condensing
Electromagnetic	Meets CE Requirements: EN 50081-2, EN 50082-2
Surge Protection	Meets CE Requirements: EN 61326 (1000 volts)
Shock Class	ANSI/ISA-S71.03 Class SA1
Vibration Class	ANSI/ISA-S71.03 Class VC2

## TRANSMITTER: PERFORMANCE

Reference Conditions	Reflection from ideal reflector at +70 °F (+20 °C)
Linearity	±0.2 inch (5 mm) or 0.05% of tank height (whichever is greater)
Measured Error	±0.2 inch (5 mm) or 0.05% of tank height (whichever is greater) <i>Within 60" (1.5m) of antenna threads, performance will begin degrading, reaching ±0.8" (2 cm) within 15" (38 cm)</i>
Resolution	0.1 inch (2.5 mm)
Repeatability	< 0.1 inch (2.5 mm) or 0.025% of tank height
Response Time	< 1 second
Warm-up Time	30 seconds
Ambient Temp. Effect	0.05% per 10 °C
Process Dielectric Effect	< 0.3 inch within selected range
Maximum Rate of Change	180 inches (450 cm)/minute
Minimum Dielectric:	1.7

## ANTENNA: FUNCTIONAL

Encapsulated Horn Antenna	Polypropylene	ETFE
Process Connection	2" NPT/BSP hygienic flanges	
Maximum Process Temperature	-40 to +200 °F @ atmos (-40 to +93 °C @ atmos)	
Maximum Process Pressure	Vacuum to 200 psig @ +70 °F (-1 to 13.8 bar @ +20 °C)	
Minimum Dielectric (application dependent)	1.7	

## ANTENNA: RATINGS PRESSURE / TEMPERATURE

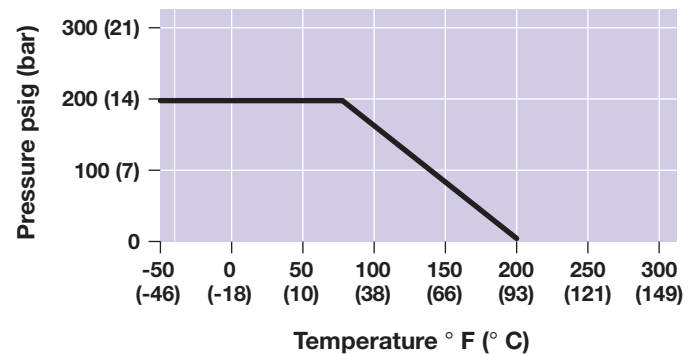

# MODEL NUMBER

Models available for quick shipment, usually within one week after factory receipt of a complete purchase order, through the Expedite Ship Plan (ESP).

## BASIC MODEL NUMBER

<b>R</b>	RADAR Level Transmitter
----------	-------------------------

## OPERATING FREQUENCY

<b>8</b>	26 GHz
----------	--------

## TRANSMITTER MODEL

<b>2</b>	Economical
----------	------------

## POWER/SIGNAL

<b>5</b>	24 VDC, Two-Wire; 4–20 mA with HART
----------	-------------------------------------

## AGENCY CLASSIFICATION

<b>1</b>	Integral, General Purpose/Non-Incendive (cFMus)
<b>2</b>	Integral, Intrinsically Safe (cFMus)
<b>A</b>	Integral, General Purpose (ATEX)
<b>B</b>	Integral, Intrinsically Safe (ATEX II 1G Ex ia IIC T4 @70°C)/IEC Ex ia IIC T4 Ga

## HOUSING/CONDUIT CONNECTION

<b>0</b>	Cast Aluminum, Single Compartment; 3/4" NPT
<b>1</b>	Cast Aluminum, Single Compartment; M20
<b>6</b>	Lexan® Plastic, Single Compartment, 3/4" NPT
<b>7</b>	Lexan Plastic, Single Compartment, M20

## ACCESSORIES

<b>A</b>	Digital Display and Keypad
----------	----------------------------

## ANTENNA TYPE

<b>1</b>	Polypropylene, 2" (50 mm) Extension
<b>2</b>	Polypropylene, 8" (200 mm) Extension
<b>3</b>	ETFE, 2" (50 mm) Extension
<b>4</b>	ETFE, 8" (200 mm) Extension

## PROCESS CONNECTION

<b>1</b>	2" NPT (Sch. 40 maximum)
<b>2</b>	2" BSP (G2) (Sch. 40 maximum)
<b>J</b>	2½" Tri-Clamp® (50 Ra surface finish)
<b>K</b>	3" Tri-Clamp® (50 Ra surface finish)

NOTE: Options J and K are available with ANTENNA TYPES 3 and 4 only (ETFE, 2" (50mm) and ETFE, 8" (200mm))

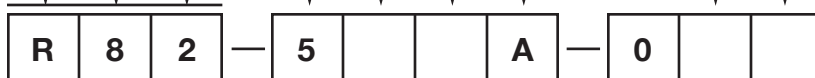

# THREAD-ON FLANGE PART NUMBERS

FOR USE WITH 2" NPT CONNECTIONS

CARBON STEEL		
2"	150#	004-6820-013
3"		004-6820-001
4"		004-6820-007
6"		004-6820-016
3"	300#	004-6820-002
4"		004-6820-008
3"	600#	004-6820-003
4"		004-6820-009

304 SS		
2"		004-6820-019
3"		004-6820-020
4"		004-6820-021
6"		004-6820-022
316 SS / 316L SS		
2"	150#	004-6820-023
3"		004-6820-024
4"		004-6820-025
6"		004-6820-026
3"	300#	004-6820-005
4"		004-6820-011
3"	600#	004-6820-006
4"		004-6820-012

FIBERGLASS	
2"	004-6823-018
3"	004-6823-019
4"	004-6823-020
KYNAR	
2"	004-6823-028
3"	004-6823-029
4"	004-6823-030
PVC	
2"	004-6823-008
3"	004-6823-009
4"	004-6823-010

## DIMENSIONAL SPECIFICATIONS

INCHES (MM)

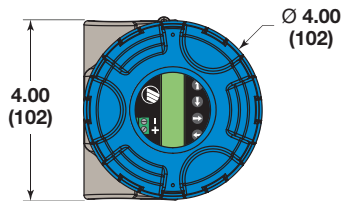

Aluminum Housing  
Top View

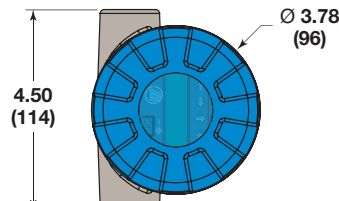

Lexan® Housing  
Top View

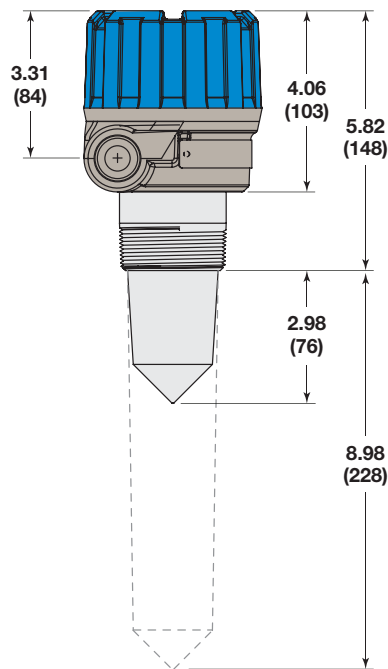

Aluminum Housing  
Side View

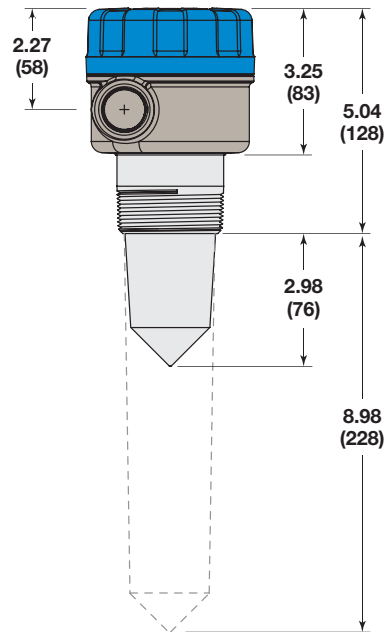

Lexan® Housing  
Side View

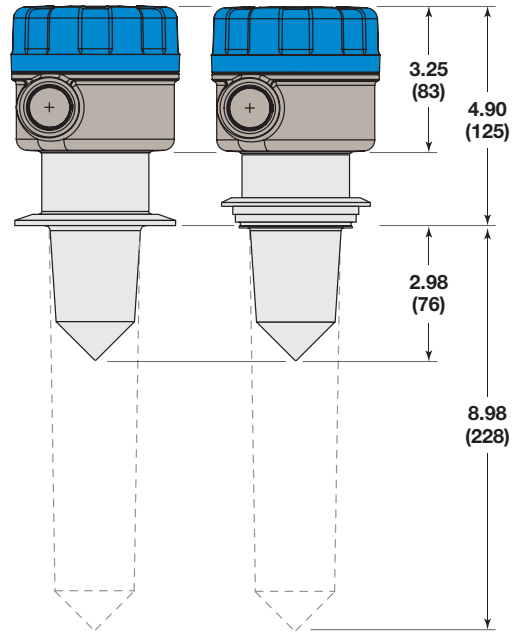

ETFE Antennas with  
Tri-Clamp and Varivent  
connections

## QUALITY

---



The quality assurance system in place at MAGNETROL guarantees the highest level of quality throughout the company. MAGNETROL is committed to providing full customer satisfaction both in quality products and quality service.

The MAGNETROL quality assurance system is registered to ISO 9001 affirming its commitment to known international quality standards providing the strongest assurance of product/service quality available.

## ESP

---

### Expedite Ship Plan

Several R82 Through-Air Radar Level Transmitters are available for quick shipment, usually within one week after factory receipt of a complete purchase order, through the Expedite Ship Plan (ESP).

Models covered by ESP service are color coded in the selection data charts.

To take advantage of ESP, simply match the color coded model number codes (standard dimensions apply).

ESP service may not apply to orders of ten units or more. Contact your local representative for lead times on larger volume orders, as well as other products and options.

## WARRANTY

---



All MAGNETROL electronic level and flow controls are warranted free of defects in materials or workmanship for eighteen months from the date of original factory shipment.

If returned within the warranty period; and, upon factory inspection of the control, the cause of the claim is determined to be covered under the warranty; then, MAGNETROL will repair or replace the control at no cost

to the purchaser (or owner) other than transportation.

MAGNETROL shall not be liable for misapplication, labor claims, direct or consequential damage or expense arising from the installation or use of equipment. There are no other warranties expressed or implied, except special written warranties covering some MAGNETROL products.

For additional information, see Instruction Manual 58-610.

Model R82 Radar transmitters may be protected by U.S. Patent No. US 7,271,646; may depend on model.



705 Enterprise Street • Aurora, Illinois 60504-8149 • 630.969.4000  
info@magnetrol.com • magnetrol.com

Copyright © 2018 Magnetrol International, Incorporated.

Performance specifications are effective with date of issue and are subject to change without notice.

Magnetrol & Magnetrol logotype and Eclipse are registered trademarks of Magnetrol International, Incorporated  
HART is a registered trademark of the HART Communication Foundation  
PACTware is trademark of PACTware Consortium  
CSA logotype is a registered trademark of Canadian Standards Association  
Tri-Clamp is a registered trademark of Ladish Co.  
Lexan is a registered trademark of General Electric  
Varivent is a registered trademark of Tuchenhagen GmbH LTD

**BULLETIN: 58-110.8**

**EFFECTIVE: September 2018**

**SUPERSEDES: August 2016**