

Digital temperature transmitter

With HART® protocol, head- and rail-mounted version

Models T32.1S, T32.3S

WIKA data sheet TE 32.04



for further approvals
see page 12



Applications

- Process industry
- Machine building and plant construction

Special features

- TÜV certified SIL version for protection systems developed per IEC 61508 (option)
- Operation in safety applications to SIL 2 (single instrument) and SIL 3 (redundant configuration)
- Configurable with almost all soft- and hardware tools
- Universal for the connection of 1 or 2 sensors
 - Resistance thermometer, resistance sensor
 - Thermocouple, mV sensor
 - Potentiometer
- Signalling per NAMUR NE43, sensor-break monitoring per NE89, EMC per NE21

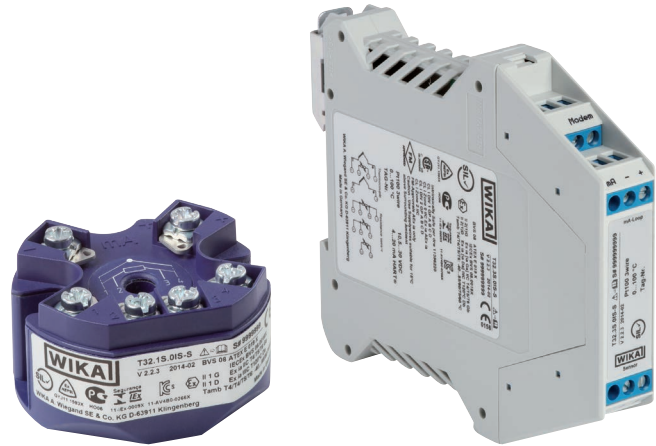

Fig. left: Head-mounted version, model T32.1S
Fig. right: Rail-mounted version, model T32.3S

Description

These temperature transmitters are designed for universal use in the process industry. They offer high accuracy, galvanic isolation and excellent protection against electromagnetic influences (EMI). Via HART® protocol, the T32 temperature transmitters are configurable (interoperable) with a variety of open configuration tools. In addition to the different sensor types, e.g. sensors in accordance with DIN EN 60751, JIS C1606, DIN 43760, IEC 60584 or DIN 43710, customer-specific sensor characteristics can also be defined, through the input of value pairs (user-defined linearisation).

Through the configuration of a sensor with redundancy (dual sensor), on a sensor failure it will automatically change over to the working sensor. Furthermore, there is the possibility to activate sensor drift detection. With this, an error signalling occurs when the magnitude of the temperature difference

between sensor 1 and sensor 2 exceeds a user-selectable value.

The T32 transmitters also have additional sophisticated supervisory functionality such as monitoring of the sensor lead resistance and sensor-break detection in accordance with NAMUR NE89 as well as monitoring of the measuring range. Moreover, these transmitters have comprehensive cyclic self-monitoring functionality.

The dimensions of the head-mounted transmitter match the form B DIN connection heads with extended mounting space, e.g. WIKA model BSS.

The rail-mounted transmitters are suitable for use in all standard rail systems in accordance with IEC 60715. The transmitters are delivered with a basic configuration or configured according to customer specifications.

Specifications

Temperature transmitter input							
Sensor type		Max. configurable measuring range ¹⁾	Standard	α values	Minimum measuring span ¹⁴⁾	Typical measuring deviation ²⁾	Temperature coefficient per °C typical ³⁾
Resistance sensor	Pt100	-200 ... +850 °C	IEC 60751:2008	$\alpha = 0.00385$	10 K or 3.8 Ω (greater value applies)	$\leq \pm 0.12$ °C ⁵⁾	$\leq \pm 0.0094$ °C ^{6) 7)}
	Pt(x) ⁴⁾ 10 ... 1000	-200 ... +850 °C	IEC 60751:2008	$\alpha = 0.00385$		$\leq \pm 0.12$ °C ⁵⁾	$\leq \pm 0.0094$ °C ^{6) 7)}
	JPt100	-200 ... +500 °C	JIS C1606: 1989	$\alpha = 0.003916$		$\leq \pm 0.12$ °C ⁵⁾	$\leq \pm 0.0094$ °C ^{6) 7)}
	Ni100	-60 ... +250 °C	DIN 43760: 1987	$\alpha = 0.00618$		$\leq \pm 0.12$ °C ⁵⁾	$\leq \pm 0.0094$ °C ^{6) 7)}
	<i>Resistance sensor</i>	0 ... 8,370 Ω			4 Ω	$\leq \pm 1.68$ Ω ⁸⁾	$\leq \pm 0.1584$ Ω ⁸⁾
	<i>Potentiometer</i> ⁹⁾	0 ... 100 %			10 %	≤ 0.50 % ¹⁰⁾	$\leq \pm 0.0100$ % ¹⁰⁾
Measuring current at the measurement		Max. 0.3 mA (Pt100)					
Connection methods		1 sensor 2-/4-/3-wire or 2 sensors 2-wire (for further information, please refer to "Designation of connection terminals")					
Max. lead resistance		50 Ω each wire, 3-/4-wire					
Thermocouple	Type J (Fe-CuNi)	-210 ... +1,200 °C	IEC 60584-1: 1995	50 K or 2 mV (greater value applies)	$\leq \pm 0.91$ °C ¹¹⁾	$\leq \pm 0.0217$ °C ^{7) 11)}	
	Type K (NiCr-Ni)	-270 ... +1,300 °C	IEC 60584-1: 1995		$\leq \pm 0.98$ °C ¹¹⁾	$\leq \pm 0.0238$ °C ^{7) 11)}	
	Type L (Fe-CuNi)	-200 ... +900 °C	DIN 43760: 1987		$\leq \pm 0.91$ °C ¹¹⁾	$\leq \pm 0.0203$ °C ^{7) 11)}	
	Type E (NiCr-Cu)	-270 ... +1,000 °C	IEC 60584-1: 1995		$\leq \pm 0.91$ °C ¹¹⁾	$\leq \pm 0.0224$ °C ^{7) 11)}	
	Type N (NiCrSi-NiSi)	-270 ... +1,300 °C	IEC 60584-1: 1995		$\leq \pm 1.02$ °C ¹¹⁾	$\leq \pm 0.0238$ °C ^{7) 11)}	
	Type T (Cu-CuNi)	-270 ... +400 °C	IEC 60584-1: 1995		$\leq \pm 0.92$ °C ¹¹⁾	$\leq \pm 0.0191$ °C ^{7) 11)}	
	Type U (Cu-CuNi)	-200 ... +600 °C	DIN 43710: 1985		$\leq \pm 0.92$ °C ¹¹⁾	$\leq \pm 0.0191$ °C ^{7) 11)}	
	Type R (PtRh-Pt)	-50 ... +1,768 °C	IEC 60584-1: 1995	150 K	$\leq \pm 1.66$ °C ¹¹⁾	$\leq \pm 0.0338$ °C ^{7) 11)}	
	Type S (PtRh-Pt)	-50 ... +1,768 °C	IEC 60584-1: 1995	150 K	$\leq \pm 1.66$ °C ¹¹⁾	$\leq \pm 0.0338$ °C ^{7) 11)}	
	Type B (PtRh-Pt)	0 ... +1,820 °C ¹⁵⁾	IEC 60584-1: 1995	200 K	$\leq \pm 1.73$ °C ¹¹⁾	$\leq \pm 0.0500$ °C ^{7) 12)}	
	<i>mV sensor</i>	-500 ... +1,800 mV			4 mV	$\leq \pm 0.33$ mV ¹³⁾	$\leq \pm 0.0311$ mV ^{7) 13)}
Connection methods		1 sensor or 2 sensors (for further information, please refer to "Designation of connection terminals")					
Max. lead resistance		5 k Ω each wire					
Cold-junction compensation, configurable		internal compensation or external with Pt100, with thermostat or off					

1) Other units e.g. °F and K possible

2) Measuring deviations (input + output) at ambient temperature 23 °C \pm 3 K, without influence of lead resistances; for example calculations see page 5

3) Temperature coefficients (input + output) per °C

4) x configurable between 10 ... 1,000

5) Based on 3-wire Pt100, Ni100, 150 °C MV

6) Based on 150 °C MV

7) In the ambient temperature range -40 ... +85 °C

8) Based on a sensor with max. 5 k Ω

9) R_{total} : 10 ... 100 k Ω

10) Based on a potentiometer value of 50 %

11) Based on 400 °C MV with cold junction compensation error

12) Based on 1000 °C MV with cold junction compensation error

13) Based on measuring range 0 ... 1 V, 400 mV MV

14) The transmitter can be configured below these limits, but this is not recommended due to loss of accuracy.

15) Specifications valid only for measuring range between 450 ... 1,820 °C

bold: basic configuration

italic: These sensors are not allowed for option SIL (T32.xS.xxx-S).

MV = measured value (temperature measured values in °C)

User linearisation

Via software, customer-specific sensor characteristics can be stored in the transmitter, so that further sensor types can be used. Number of data points: minimum 2; maximum 30

Monitoring functionality by connection of 2 sensors (dual sensor)

Redundancy

In the case of a sensor error (sensor break, lead resistance too high or outside the measuring range of the sensor) of one of the two sensors, the process value will be only based on the error-free sensor. Once the error is rectified, the process value will again be based on the two sensors, or on sensor 1.

Ageing control (sensor-drift monitoring)

An error signalling on the output is activated if the value of the temperature difference between sensor 1 and sensor 2 is higher than a set value, which can be selected by the user. This monitoring only generates a signal if two valid sensor values can be determined and the temperature difference is higher than the selected limit value.

(Cannot be selected for the "Difference" sensor function, since the output signal already indicates the difference value).

Sensor functionality when 2 sensors have been connected (dual sensor)

Sensor 1, sensor 2 redundant:

The 4 ... 20 mA output signal delivers the process value of sensor 1. If sensor 1 fails, the process value of sensor 2 is output (sensor 2 is redundant).

Mean value

The 4 ... 20 mA output signal delivers the mean value of the two values from sensor 1 and sensor 2. If one sensor fails, the process value of the error-free sensor is output.

Minimum value

The 4 ... 20 mA output signal delivers the lower of the two values from sensor 1 and sensor 2. If one sensor fails, the process value of the error-free sensor is output.

Maximum value

The 4 ... 20 mA output signal delivers the higher of the two values from sensor 1 and sensor 2. If one sensor fails, the process value of the error-free sensor is output.

Difference ¹⁾

The 4 ... 20 mA output signal delivers the difference between sensor 1 and sensor 2. If one sensor fails, an error signalling will be activated.

Note:

The transmitter can be configured below these limits, but this is not recommended due to loss of accuracy.

Analogue output, output limits, signalling, insulation resistance

Analogue output, configurable	linear to temperature per IEC 60751 , JIS C1606, DIN 43760 (for resistance sensors) or linear to temperature per IEC 584 / DIN 43710 (for thermocouples) 4 ... 20 mA or 20 ... 4 mA, 2-wire	
Output limits, configurable per NAMUR NE43 customer-specifically adjustable Option SIL (T32.xS.xxx-S)	lower limit 3.8 mA 3.6 ... 4.0 mA 3.8 ... 4.0 mA	upper limit 20.5 mA 20.0 ... 21.5 mA 20.0 ... 20.5 mA
Current value for signalling, configurable per NAMUR NE43 Setting range	downscale < 3.6 mA (3.5 mA) 3.5 ... 3.6 mA	upscale > 21.0 mA (21.5 mA) 21.0 ... 22.5 mA
PV (primary value; digital HART® measured value)	Signalling on sensor and hardware error through default value	
In simulation mode, independent from input signal, simulation value configurable from 3.5 ... 23.0 mA		
Load R _A (without HART®)	$R_A \leq (U_B - 10.5 \text{ V}) / 0.023 \text{ A}$ with R _A in Ω and U _B in V	
Load R _A (with HART®)	$R_A \leq (U_B - 11.5 \text{ V}) / 0.023 \text{ A}$ with R _A in Ω and U _B in V	
Insulation voltage (input to analogue output)	AC 1,200 V, (50 Hz / 60 Hz); 1 s	

Rise time, damping, measuring rate

Rise time t ₉₀	approx. 0.8 s
Damping, configurable	off ; configurable between 1 s and 60 s
Switch-on time (time to get the first measured value)	max. 15 s
Typical measuring rate ²⁾	Measured value update approx. 6/s

bold: basic configuration

1) This operating mode is not allowed with SIL option (T32.xS.xxx-S).

2) Valid only for RTD/single thermocouple sensor

Measuring deviation, temperature coefficient, long-term stability					
Effect of load		Not measurable			
Power supply effect		Not measurable			
Warm-up time		After approx. 5 minutes the instrument will function to the specifications (accuracy)			
Input	Measuring deviation at reference conditions in accordance with DIN EN 60770, NE 145, valid at 23 °C ± 3 K	Mean temperature coefficient (TC) for each 10 K change in ambient temperature in the range -40 ... +85 °C ¹⁾	Lead resistance effects	Long-term stability after 1 year	
■ Resistance thermometer Pt100 ²⁾ / JPt100/Ni100	-200 °C ≤ MV ≤ 200 °C: ±0.10 K MV > 200 °C: ±(0.1 K + 0.01 % IMV-200 K) ³⁾	±(0.06 K + 0.015 % MV)	4-wire: no effect (0 to 50 Ω each wire) 3-wire: ±0.02 Ω / 10 Ω (0 to 50 Ω each wire) 2-wire: resistor of the connection lead ⁴⁾	±60 mΩ or 0.05 % of MV, greater value applies	
■ Resistance sensor ⁵⁾	≤ 890 Ω: 0.053 Ω ⁶⁾ or 0.015 % MV ⁷⁾ ≤ 2140 Ω: 0.128 Ω ⁶⁾ or 0.015 % MV ⁷⁾ ≤ 4390 Ω: 0.263 Ω ⁶⁾ or 0.015 % MV ⁷⁾ ≤ 8380 Ω: 0.503 Ω ⁶⁾ or 0.015 % MV ⁷⁾	±(0.01 Ω + 0.01 % MV)			
■ Potentiometer ⁵⁾	R _{part} /R _{total} is max. ±0.5 %	±(0.1 % MV)		±20 μV or 0.05 % of MV, greater value applies	
■ Thermocouples Type E, J	-150 °C < MV < 0 °C: ±(0.3 K + 0.2 % IMV) MV > 0 °C: ±(0.3 K + 0.03 % MV)	Type E: MV > -150 °C: ±(0.1 K + 0.015 % IMV) Type J: MV > -150 °C: ±(0.07 K + 0.02 % IMV)	6 μV / 1,000 Ω ⁸⁾		
Type T, U	-150 °C < MV < 0 °C: ±(0.4 K + 0.2 % IMV) MV > 0 °C: ±(0.4 K + 0.01 % MV)	-150 °C < MV < 0 °C: ±(0.07 K + 0.04 % MV) MV > 0 °C: ±(0.07 K + 0.01 % MV)			
Type R, S	50 °C < MV < 400 °C: ±(1.45 K + 0.12 % IMV - 400 K) 400 °C < MV < 1600 °C: ±(1.45 K + 0.01 % IMV - 400 K)	Type R: 50 °C < MV < 1,600 °C: ±(0.3 K + 0.01 % IMV - 400 K) Type S: 50 °C < MV < 1600 °C: ±(0.3 K + 0.015 % IMV - 400 K)			
Type B	450 °C < MV < 1,000 °C: ±(1.7 K + 0.2 % IMV - 1,000 K) MV > 1,000 °C: ±1.7 K	450 °C < MV < 1,000 °C: ±(0.4 K + 0.02 % IMV - 1,000 K) MV > 1,000 °C: ±(0.4 K + 0.005 % (MV - 1,000 K))			
Type K	-150 °C < MV < 0 °C: ±(0.4 K + 0.2 % IMV) 0 °C < MV < 1,300 °C: ±(0.4 K + 0.04 % MV)	-150 °C < MV < 1,300 °C: ±(0.1 K + 0.02 % IMV)			
Type L	-150 °C < MV < 0 °C: ±(0.3 K + 0.1 % IMV) MV > 0 °C: ±(0.3 K + 0.03 % MV)	-150 °C < MV < 0 °C: ±(0.07 K + 0.02 % IMV) MV > 0 °C: ±(0.07 K + 0.015 % MV)			
Type N	-150 °C < MV < 0 °C: ±(0.5 K + 0.2 % IMV) MV > 0 °C: ±(0.5 K + 0.03 % MV)	-150 °C < MV < 0 °C: ±(0.1 K + 0.05 % IMV) MV > 0 °C: ±(0.1 K + 0.02 % MV)			
■ mV sensor ⁵⁾	≤ 1,160 mV: 10 μV + 0.03 % IMV > 1,160 mV: 15 μV + 0.07 % IMV	2 μV + 0.02 % IMV 100 μV + 0.08 % IMV			
■ Cold junction ⁹⁾	±0.8 K	±0.1 K			
Output	±0.03 % of measuring span	±0.03 % of measuring span			±0.05 % of span

Total measuring deviation

Addition: input + output per DIN EN 60770, 23 °C ± 3 K

MV = measured value (temperature measured values in °C)

Measuring span = configured end of measuring range - configured start of measuring range

- 1) T32.1S: with the extended ambient temperature (-50 ... -40 °C) the value is doubled
- 2) For sensor Pt_x (x = 10 ... 1,000) applies:
for x ≥ 100: permissible error, as for Pt100
for x < 100: permissible error, as for Pt100 with a factor (100/x)
- 3) Additional error for resistance thermometers in a 3-wire configuration with zero-balanced cable: 0.05 K
- 4) The specified resistance value of the sensor wire can be subtracted from the calculated sensor resistance.
Dual sensor: configurable for each sensor separately

- 5) This operating mode is not allowed for SIL option (T32.xS.xxx-S).
- 6) Double value at 3-wire
- 7) Greater value applies
- 8) Within a range of 0 ... 10 kΩ lead resistance
- 9) Only for thermocouple

Basic configuration:

Input signal: Pt100 in 3-wire connection, measuring range: 0 ... 150 °C

Example calculation

Pt100 / 4-wire / measuring range 0 ... 150 °C / ambient temperature 33 °C	
Input Pt100, MV < 200 °C	±0.100 K
Output ±(0.03 % of 150 K)	±0.045 K
TC _{input} ±(0.06 K + 0.015 % of 150 K)	±0.083 K
TC _{output} ±(0.03 % of 150 K)	±0.045 K
Measuring deviation (typical) $\sqrt{\text{input}^2 + \text{output}^2 + \text{TC}_{\text{input}}^2 + \text{TC}_{\text{output}}^2}$	±0.145 K
Measuring deviation (maximum) (input + output + TC _{input} + TC _{output})	±0.273 K

Thermocouple type K / measuring range 0 ... 400 °C / internal compensation (cold junction) / ambient temperature 23 °C	
Input type K, 0 °C < MV < 1,300 °C ±(0.4 K + 0.04 % of 400 K)	±0.56 K
Cold junction ±0.8 K	±0.80 K
Output ±(0.03 % of 400 K)	±0.12 K
Measuring deviation (typical) $\sqrt{\text{input}^2 + \text{cold junction}^2 + \text{output}^2}$	±0.98 K
Measuring deviation (maximum) (input + cold junction + output)	±1.48 K

Pt1000 / 3-wire / measuring range -50 ... +50 °C / ambient temperature 45 °C	
Input Pt1000, MV < 200 °C	±0.100 K
Output ±(0.03 % of 100 K)	±0.03 K
TC _{input} ±(0.06 K + 0.015 % of 100 K) * 2	±0.15 K
TC _{output} ±(0.03 % of 100 K) * 2	±0.06 K
Measuring deviation (typical) $\sqrt{\text{input}^2 + \text{output}^2 + \text{TC}_{\text{input}}^2 + \text{TC}_{\text{output}}^2}$	±0.19 K
Measuring deviation (maximum) (input + output + TC _{input} + TC _{output})	±0.34 K

Monitoring	
Test current for sensor monitoring ¹⁾	Nom. 20 µA during test cycle, otherwise 0 µA
Monitoring NAMUR NE89 (monitoring of input lead resistance)	
■ Resistance thermometer (Pt100, 4-wire)	R _{L1} + R _{L4} > 100 Ω with hysteresis 5 Ω R _{L2} + R _{L3} > 100 Ω with hysteresis 5 Ω
■ Thermocouple	R _{L1} + R _{L4} + R _{thermocouple} > 10 kΩ with hysteresis 100 Ω
Sensor break monitoring	Always active
Self-monitoring	Active permanently, e.g. RAM/ROM test, logical program operating checks and validity check
Measuring range monitoring	Monitoring of the set measuring range for upper/lower deviations Standard: deactivated
Monitoring of input lead resistance (3-wire)	Monitoring of the resistance difference between lead 3 and 4; an error will be indicated if there is a difference of > 0.5 Ω between leads 3 and 4

1) Only for thermocouple

Explosion protection, power supply					
Model	Approvals	Permissible ambient/ storage temperature (in accordance with the relevant temperature classes)	Safety-related maximum values for		Power supply U_B (DC) ³⁾
			Sensor (Connections 1 - 4)	Current loop Connections \pm)	
T32.xS.000	without	-60 ¹⁾ / -50 ²⁾ / -40 ... +85 °C	-	-	10.5 ... 42 V
T32.1S.0IS, T32.3S.0IS	EC-type examination certificate: BVS 08 ATEX E 019 X and IECEx certificate BVS 08.0018X ■ T32.1S Zones 0, 1: II 1G Ex ia IIC T4/T5/T6 Ga Zones 20, 21: II 1D Ex ia IIIC T120 °C Da Intrinsically safe per ATEX directive and IECEx scheme ■ T32.3S Zones 0, 1: II 2(1) G Ex ia [ia Ga] IIC T4/T5/T6 Gb Zones 20, 21: II 2(1) D Ex ia [ia Da] IIIC T120 °C Db Intrinsically safe per ATEX directive and IECEx scheme	Gas, category 1 and 2 -50 ²⁾ / -40 ... +85 °C (T4) -50 ²⁾ / -40 ... +75 °C (T5) -50 ²⁾ / -40 ... +60 °C (T6) Dust, category 1 + 2 -50 ²⁾ / -40 ... +40 °C ($P_i < 750$ mW) -50 ²⁾ / -40 ... +75 °C ($P_i < 650$ mW) -50 ²⁾ / -40 ... +100 °C ($P_i < 550$ mW)	$U_o = DC 6.5 V$ $I_o = 9.3 mA$ $P_o = 15.2 mW$ $C_i = 208 nF$ $L_i = negligible$ Gas, category 1 and 2 IIC: $C_o = 24 \mu F$ ⁴⁾ $L_o = 365 mH$ $L_o/R_o = 1.44 mH/\Omega$ IIA: $C_o = 1,000 \mu F$ ⁴⁾ $L_o = 3,288 mH$ $L_o/R_o = 11.5 \mu H/\Omega$ Category 1 and 2, gas IIB, dust IIIC $C_o = 570 \mu F$ ⁴⁾ $L_o = 1,644 mH$ $L_o/R_o = 5.75 \mu H/\Omega$	Gas, category 1 + 2 $U_i = DC 30 V$ $I_i = 130 mA$ $P_i = 800 mW$ $C_i = 7.8 nF$ $L_i = 100 \mu H$ Dust, category 1 + 2 $U_i = DC 30 V$ $I_i = 130 mA$ $P_i = 750/650/550 mW$ $C_i = 7.8 nF$ $L_i = 100 \mu H$	10.5 ... 30 V
T32.1S.0IS, T32.3S.0IS	CSA approval 70038032 Intrinsically safe installation per drawing 11396220 Class I, zone 0, Ex ia IIC Class I, zone 0, AEx ia IIC Non-incendive field wiring per drawing 11396220 Class I, division 2, group A, B, C, D	-50 ²⁾ / -40 ... +80 °C (T4) -50 ²⁾ / -40 ... +75 °C (T5) -50 ²⁾ / -40 ... +60 °C (T6)		$V_{max} = DC 30 V$ $I_{max} = 130 mA$ $P_i = 800 mW$ $C_i = 7.8 nF$ $L_i = 100 \mu H$	10.5 ... 30 V
T32.1S.0IS, T32.3S.0IS	FM approval 3034620 / FM17US0333X Intrinsically safe installation per drawing 11396220 Class I, zone 0, AEx ia IIC Class I, division 1, group A, B, C, D FM approval AEx ia only Non-incendive field wiring per drawing 11396220 Class I, division 2, group A, B, C, D Class I, division 2, IIC	-50 ²⁾ / -40 ... +85 °C (T4) -50 ²⁾ / -40 ... +75 °C (T5) -50 ²⁾ / -40 ... +60 °C (T6)	$V_{oc} = 6.5 V$ $I_{sc} = 9.3 mA$ $P_{max} = 15.2 mW$ $C_a = 24 \mu F$ $L_a = 365 \mu H$	$V_{max} = DC 30 V$ $I_{max} = 130 mA$ $P_i = 800 mW$ $C_i = 7.8 nF$ $L_i = 100 \mu H$	10.5 ... 30 V
T32.1S.0IS, T32.3S.0IS	Intrinsically safe equipment RU C-DE.ГБ08.B.02485 0 Ex ia IIC T4/T5/T6 1 Ex ib IIC T4/T5/T6 2 Ex ic IIC T4/T5/T6 Ex nA II T4/T5/T6 DIP A20 Ta 120 °C DIP A21 Ta 120 °C	-60 ¹⁾ / -50 ²⁾ / -40 ... +85 °C (T4) -60 ¹⁾ / -50 ²⁾ / -40 ... +75 °C (T5) -60 ¹⁾ / -50 ²⁾ / -40 ... +60 °C (T6)	$V_{oc} = 6.5 V$ $I_{sc} = 9.3 mA$ $P_{max} = 15.2 mW$ $C_a = 24 \mu F$ $L_a = 365 \mu H$	$V_{max} = DC 30 V$ $I_{max} = 130 mA$ $P_i = 800 mW$ $C_i = 7.8 nF$ $L_i = 100 \mu H$	10.5 ... 30 V
T32.1S.0NI, T32.3S.0NI	II 3G Ex nA IIC T4/T5/T6 Gc X	-50 ²⁾ / -40 ... +85 °C (T4) -50 ²⁾ / -40 ... +75 °C (T5) -50 ²⁾ / -40 ... +60 °C (T6)	$U_o = DC 3.1 V$ $I_o = 0.26 mA$ $C_i = 208 nF$ $L_i = negligible$ $C_o \leq 1,000 \mu F$ $L_o \leq 1,000 mH$ Ratio L/R (for ignition protection type ic) $L_o/R_o \leq 9 mH/\Omega$ (for IIC) $L_o/R_o \leq 39 mH/\Omega$ (for IIB) $L_o/R_o \leq 78 mH/\Omega$ (for IIA)	$U_i = DC 40 V$ $I_i = 23 mA$ ⁵⁾ $P_i = 1 W$ $C_i = 7.8 nF$ $L_i = 100 \mu H$	10.5 ... 40 V

1) Special version on request (only available with specific approvals), not for rail-mounted version T32.3S, not for SIL version

2) Special version, not for rail-mounted version T32.3S

3) Power supply input protected against reverse polarity; Load $R_A \leq (U_B - 10.5 V) / 0.023 A$ with R_A in Ω and U_B in V (without HART®)

On switching on, an increase in the power supply of 2 V/s is needed; otherwise the temperature transmitter will remain in a safe condition at 3.5 mA.

4) C_i already considered

5) The maximum operating current is limited by the T32. The maximum current of the associated energy-limited equipment should not be ≤ 23 mA.

Explosion protection, power supply					
Model	Approvals	Permissible ambient/ storage temperature (in accordance with the relevant temperature classes)	Safety-related maximum values for		Power supply U_B (DC) ³⁾
			Sensor (Connections 1 - 4)	Current loop Connections \pm)	
T32.1S.0IC, T32.3S.0IC	II 3G Ex ic IIC T4/T5/T6 Gc	-50 ²⁾ / -40 ... +85 °C (T4) -50 ²⁾ / -40 ... +75 °C (T5) -50 ²⁾ / -40 ... +60 °C (T6)	$U_o = DC 6.5 V$ $I_o = 9.3 mA$ $C_i = 208 nF$ $L_i = negligible$ IIC: $C_o \leq 325 \mu F$ ⁴⁾ $L_o \leq 821 mH$ $L_o/R_o \leq 3.23 mH/\Omega$ IIA: $C_o \leq 1,000 \mu F$ ⁴⁾ $L_o \leq 7,399 mH$ $L_o/R_o \leq 25.8 mH/\Omega$ IIB IIC: $C_o \leq 570 \mu F$ ⁴⁾ $L_o \leq 3,699 mH$ $L_o/R_o \leq 12.9 mH/\Omega$	$U_i = DC 30 V$ $I_i = 130 mA$ $P_i = 800 mW$ $C_i = 7.8 nF$ $L_i = 100 \mu H$	10.5 ... 30 V

Ambient conditions	
Permissible ambient temperature range	-60 ¹⁾ / -50 ²⁾ / -40 ... +85 °C
Climate class per IEC 654-1: 1993	Cx (-40 ... +85 °C, 5 ... 95 % r. h.)
Maximum permissible humidity	Test max. temperature variation 65 °C and -10 °C, 93 % \pm 3 % r. h. Test max. temperature 55 °C, 95 % r. h.
Vibration resistance per IEC 60068-2-6:2007 <ul style="list-style-type: none"> ■ Model T32.1S per IEC 60068-2-38: 1974 ■ Model T32.3S per IEC 60068-2-30: 2005 	
Shock resistance per IEC 68-2-27: 1987	Test Ea: acceleration type I 30 g and type II 100 g
Salt fog per IEC 60068-2-52	Severity level 1
Freefall in accordance with IEC 60721-3-2: 1997	Drop height 1,500 mm
Electromagnetic compatibility (EMC) ⁶⁾	EN 61326 emission (Group 1, Class B) and interference immunity (industrial application), and also per NAMUR NE21

Case	T32.1S head-mounted version	T32.3S rail-mounted version
Material	Plastic PBT, glass-fibre reinforced	Plastic
Weight	0.07 kg	0.2 kg
Ingress protection ⁷⁾	IP00 Electronics completely potted	IP20
Connection terminals, captive screws, wire cross-section		
<ul style="list-style-type: none"> ■ Solid wire ■ Wire with end splice 	0.14 ... 2.5 mm ² (AWG 24 ... 14) 0.14 ... 1.5 mm ² (AWG 24 ... 16)	0.14 ... 2.5 mm ² (AWG 24 ... 14) 0.14 ... 2.5 mm ² (AWG 24 ... 14)

Model T32.1R (option)	
Higher measuring rate	Measured value update approx. 14/s
Limited accuracy	Multiply the accuracy limit values given for the model T32.xS by factor 2
Limited sensor diagnostics	Limited self-monitoring function
Sensor input	Only for thermocouples
SIL certification	Without
External cold junction	Without
Dual sensor function	Without

1) Special version on request (only available with specific approvals), not for rail-mounted version T32.3S, not for SIL version

2) Special version, not for rail-mounted version T32.3S

3) Power supply input protected against reverse polarity; Load $R_A \leq (U_B - 10.5 V) / 0.023 A$ with R_A in Ω and U_B in V (without HART[®])

On switching on, an increase in the power supply of 2 V/s is needed; otherwise the temperature transmitter will remain in a safe condition at 3.5 mA.

4) C_i already considered

5) The maximum operating current is limited by the T32. The maximum current of the associated energy-limited equipment should not be $\leq 23 mA$.

6) During interference take into account an increased measuring deviation of up to 1 %.

7) Ingress protection per IEC/EN 60529

Communication HART® protocol rev. 5 ¹⁾ including burst mode and multidrop

Interoperability (i.e. compatibility between components from different manufacturers) is a strict requirement of HART® instruments. The T32 transmitter is compatible with almost every open software and hardware tool; including:

1. User-friendly WIKA configuration software, free-of-charge download from www.wika.com
2. HART® communicator FC375, FC475, MFC4150, MFC5150, Trex:
T32 device description (device object file) is integrated and upgradable with old versions
3. Asset management systems
 - 3.1 AMS: T32_DD completely integrated and upgradable with old versions
 - 3.2 Simatic PDM: T32_EDD completely integrated from version 5.1, upgradable with version 5.0.2
 - 3.3 Smart Vision: DTM upgradable per FDT 1.2 standard from SV version 4
 - 3.4 PACTware: DTM completely integrated and upgradable as well as all supporting applications with FDT 1.2 interface
 - 3.5 Field Mate: DTM upgradable

Attention:

For direct communication via the serial interface of a PC/notebook, a HART® modem is needed (see "Accessories").

As a general rule, parameters which are defined in the scope of the universal HART® commands (e.g. the measuring range) can, in principle, be edited with all HART® configuration tools.

1) Optional: rev. 7

Load diagram

The permissible load depends on the loop supply voltage.

Load $R_A \leq (U_B - 10.5 \text{ V}) / 0.023 \text{ A}$ with R_A in Ω and U_B in V (without HART®)

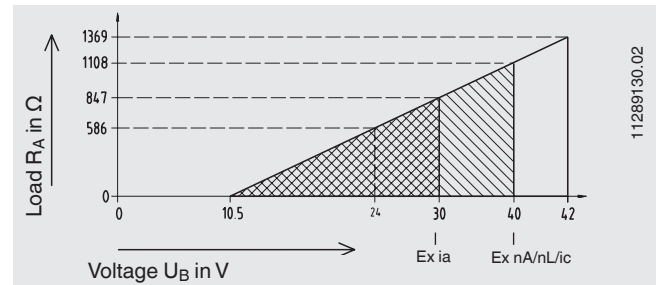

Designation of connection terminals

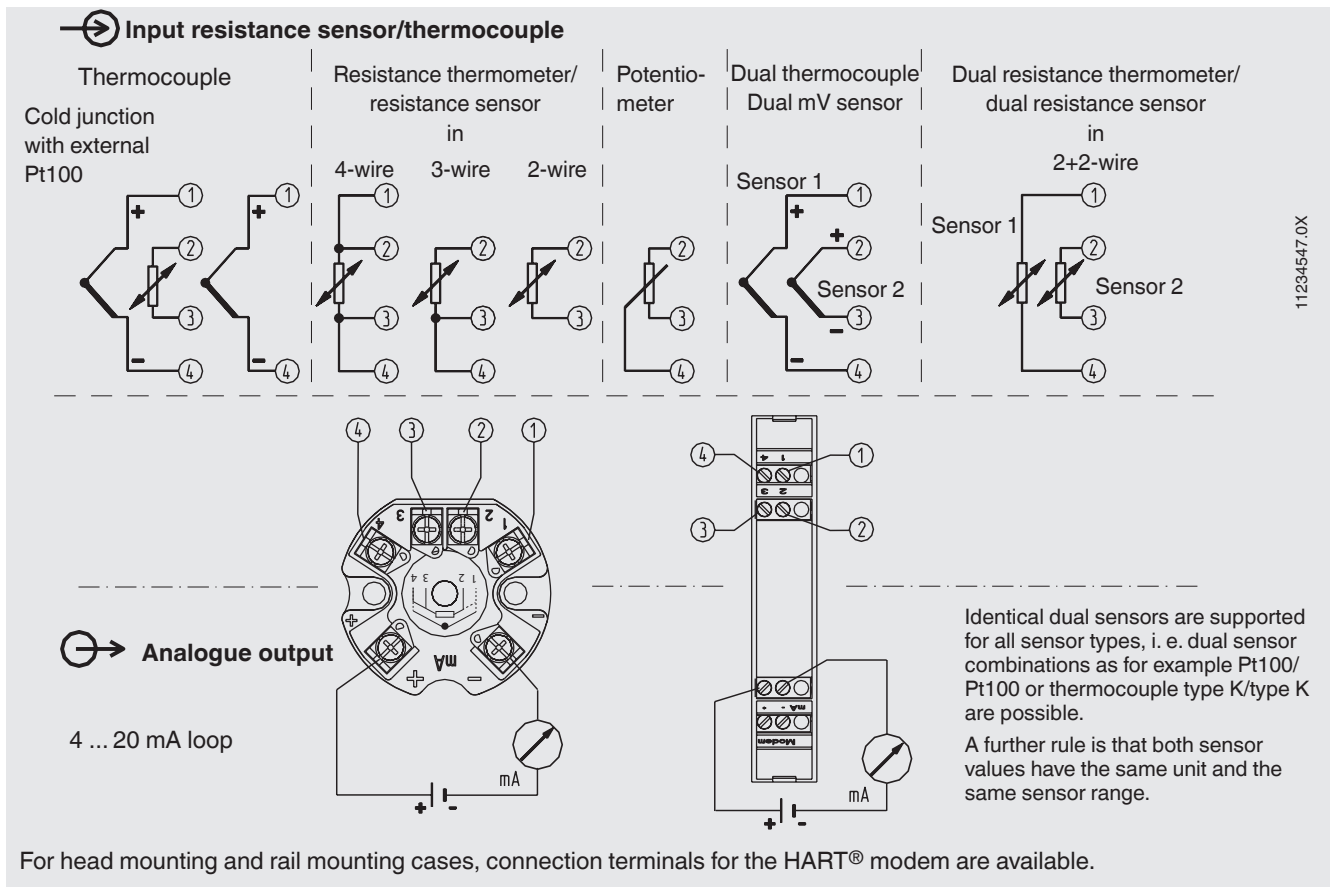

11234547.0X

Dimensions in mm

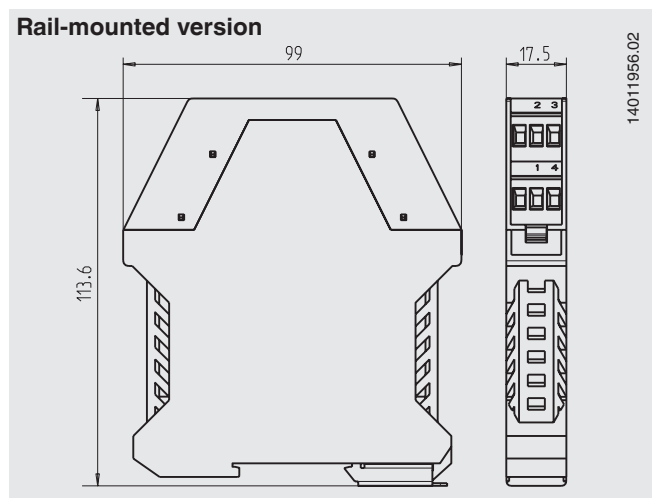
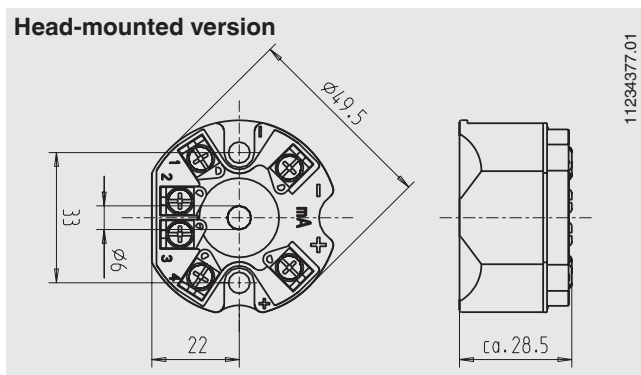

Typical connection for hazardous areas

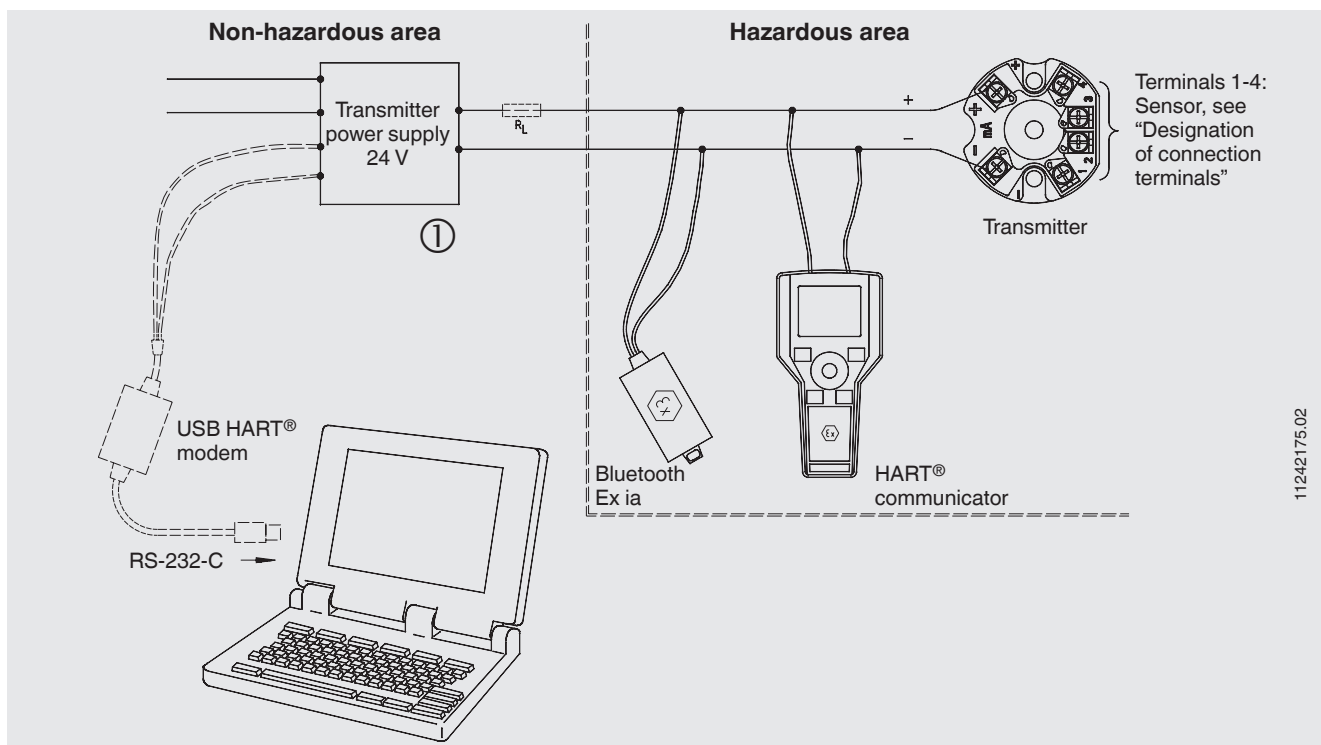

Typical connection for non-hazardous areas

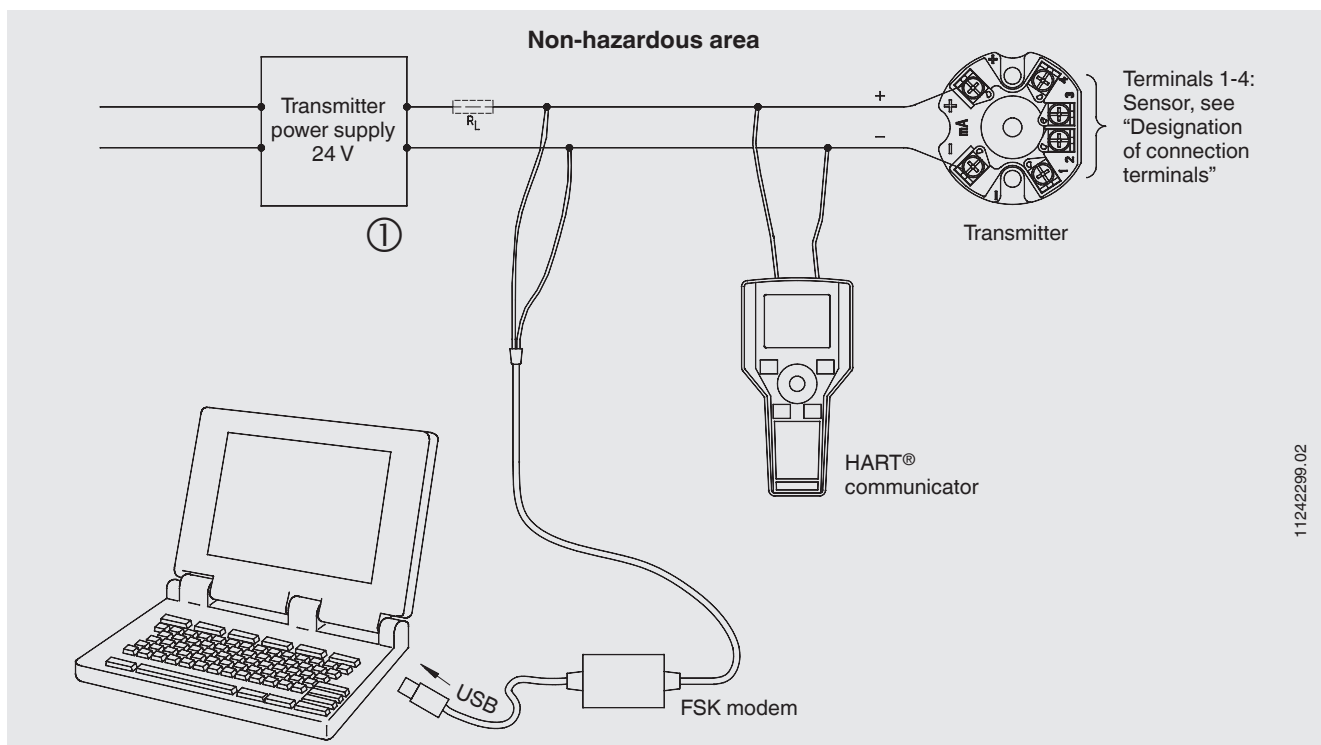

- ① RL = Load resistance for HART® communication
RL min. 250 Ω, max. 1.100 Ω





If RL is < 250 Ω in the respective electrical circuit, RL must be increased to at least 250 Ω by connecting external resistors.

In case of a failure, sporadic communication impairments may occur at very high ambient temperatures, downscale error signal and poor load.





Accessories

WIKA configuration software: free download from www.wika.com















DIH50-F with field case, adapter

Model	Description	Order number
DIH50, DIH52 with field case 	DIH50 indication module without separate auxiliary power supply, automatically rescales on a change in measuring range and units via supervision of the HART® communication, 5-digit LC display, 20-segment bar graph display, display rotatable in 10° steps, with II 1G Ex ia IIC explosion protection; see data sheet AC 80.10 <ul style="list-style-type: none"> Material: Aluminium / stainless steel Dimensions: 150 x 127 x 138 mm 	on request
Adapter 	<ul style="list-style-type: none"> Suitable for TS 35 per DIN EN 60715 (DIN EN 50022) or TS 32 per DIN EN 50035 Material: Plastic / stainless steel Dimensions: 60 x 20 x 41,6 mm 	3593789
Adapter 	<ul style="list-style-type: none"> Suitable for TS 35 per DIN EN 60715 (DIN EN 50022) Material: Steel tin galvanized Dimensions: 49 x 8 x 14 mm 	3619851
Magnetic quick connector magWIK 	<ul style="list-style-type: none"> Replacement for crocodile clips and HART® terminals Fast, safe and tight electrical connection For all configuration and calibration processes 	14026893

HART® modem

Model	Description	Order number
Programming unit, model PU-H		
VIATOR® HART® USB 	HART® modem for USB interface	11025166
VIATOR® HART® USB PowerXpress™ 	HART® modem for USB interface	14133234
VIATOR® HART® RS-232 	HART® modem for RS-232 interface	7957522
VIATOR® HART® Bluetooth® Ex 	HART® modem for Bluetooth interface, Ex	11364254

Approvals

Logo	Description	Country
	EU declaration of conformity <ul style="list-style-type: none"> ■ EMC directive EN 61326 emission (group 1, class B) and interference immunity (industrial application) ■ RoHS directive ■ ATEX directive (option) Hazardous areas 	European Union
		
	IECEx (option) Hazardous areas	International
	FM (option) Hazardous areas	USA
	CSA (option) Hazardous areas	Canada
	EAC (option) <ul style="list-style-type: none"> ■ EMC directive ■ Hazardous areas (option) 	Eurasian Economic Community
	GOST (option) Metrology, measurement technology	Russia
-	MTSCHS (option) Permission for commissioning	Kazakhstan
	BelGIM (option) Metrology, measurement technology	Belarus
	UkrSEPRO (option) Metrology, measurement technology	Ukraine
	DNOP - MakNII (option) <ul style="list-style-type: none"> ■ Mining ■ Hazardous areas 	Ukraine
	Uzstandard (option) Metrology, measurement technology	Usbekistan
	INMETRO (option) Hazardous areas	Brazil
	NEPSI (option) Hazardous areas	China
	KCs - KOSHA (option) Hazardous areas	South Korea

Manufacturer's information and certifications

Logo	Description
	SIL 2 (option) Functional safety
-	China RoHS directive

Certificates (option)

- 2.2 test report
- 3.1 inspection certificate
- DKD/DAkkS calibration certificate

Approvals and certificates, see website

Ordering information

Model / Explosion protection / SIL specifications / Configuration / Permissible ambient temperature / Certificates / Options

© 04/2008 WIKA Alexander Wiegand SE & Co. KG, all rights reserved.
The specifications given in this document represent the state of engineering at the time of publishing.
We reserve the right to make modifications to the specifications and materials.



WIKA Alexander Wiegand SE & Co. KG
Alexander-Wiegand-Straße 30
63911 Klingenberg/Germany
Tel. +49 9372 132-0
Fax +49 9372 132-406
info@wika.de
www.wika.de