

Precision SMU Quick Response for Automated Testing

GS820
Multi Channel
Source Measure Unit
18 V/50 V range models



LED lighting is making our environment more comfortable, bright, and relaxed. Mobile devices, including wearable devices, now need smaller and more energy efficient parts than ever before.

Nearly 100 years of instrumentation and measurement technology experience has enabled us to develop this versatile DC generator, both for source and measurement.

Two models of the GS820 are available. Both the 18 Volt and 50 Volt range models provide solutions for testing various electrical parts.

The GS820 delivers:

Productivity — High speed communication improves the productivity of the electric parts.

Customizability — 100000 points programmable generation makes any test you want possible.

Visibility — Ease of capturing I/V Curve causes visible and agile result.

Features

- Isolated 2-channel source and measurement function
- Source and measurement ranges
18 V model: 7 V and 3.2 A or 18 V and 1.2 A
50 V model: 20 V and 1.2 A or 50 V and 0.6 A
- 1pA resolution at extremely small current range 200 nA
- Generate arbitrary waveforms consisting of up to 100000 points at 100 μ s intervals
- Channel expansion through master-slave synchronization link
- Fast test speeds
- 16 bit digital I/O (model 765602/12)

Application Examples

- DC voltage/current reference
- Semiconductor parametric test
- Electronic load
- Programmable arbitrary waveform generation
- I/V curve trace
- Pulse voltage/current source
- Resistance measurement
- Production test

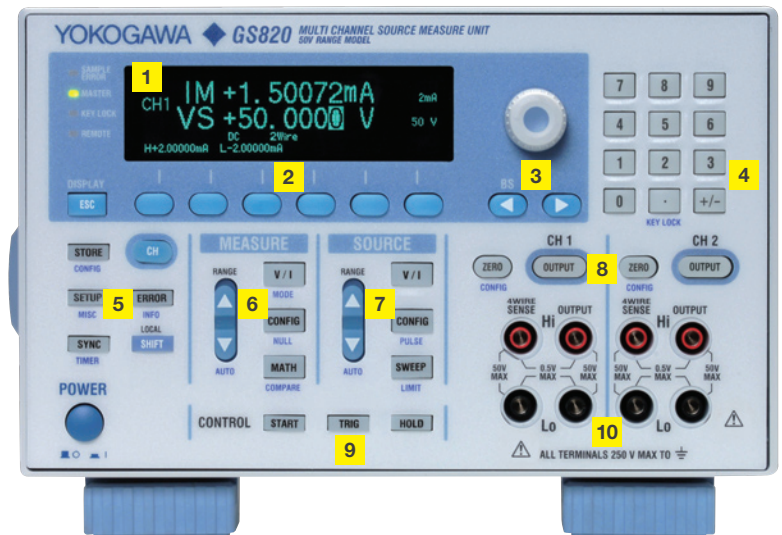

- | | |
|---------------------|------------------------|
| 1 VFD display | 6 Measure setup keys |
| 2 Soft keys | 7 Source setup keys |
| 3 Rotary knob | 8 Output control keys |
| 4 Numeric keys | 9 Trigger control keys |
| 5 Common setup keys | 10 Output terminals |

Source and Measurement Range

Four-quadrant operation consisting of source operation (current source) and sink operation (current sink) is available. The output and measurement resolutions are 5.5 digits. Two models are available for your application.

18 V model (765601/02)

Voltage ranges: 200 mV, 2 V, 7 V, and 18 V
 Maximum output current: ± 3.2 A (at an output voltage of ± 7 V or less)
 ± 1.2 A (at an output voltage of ± 18 V or less)
 Current ranges: 200 nA, 2 μ A, 20 μ A, 200 μ A, 2 mA, 20 mA, 200 mA, 1 A, and 3 A
 Maximum output voltage: ± 18 V (at an output current of ± 1.2 A or less)
 ± 7 V (at an output current of ± 3.2 A or less)

50 V model (765611/12)

Voltage ranges: 200 mV, 2 V, 20 V, and 50 V
 Maximum output current: ± 1.2 A (at an output voltage of ± 20 V or less)
 ± 0.6 A (at an output voltage of ± 50 V or less)
 Current ranges: 200 nA, 2 μ A, 20 μ A, 200 μ A, 2 mA, 20 mA, 200 mA, 0.5 A, and 1 A
 Maximum output voltage: ± 50 V (at an output current of ± 0.6 A or less)
 ± 20 V (at an output current of ± 1.2 A or less)

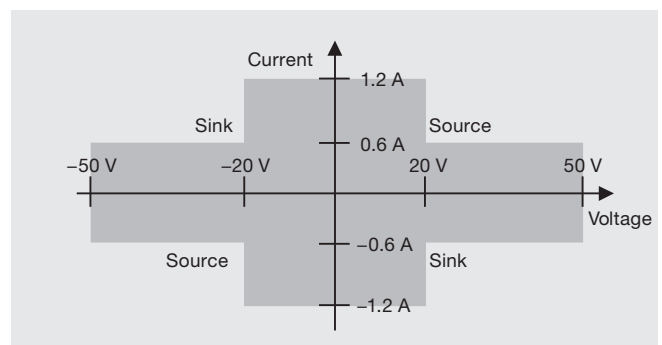
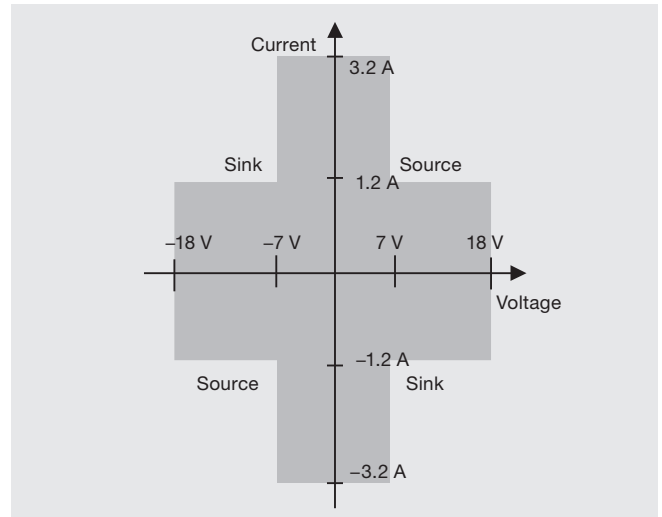

GS820 Construction and Functions

The GS820 is equipped with two analog channels with each channel consisting of a constant voltage source VS, a constant current source IS, a voltmeter VM, and an ammeter IM.

The two source measure channels are isolated.

Source and Measurement Functions

- Voltage source and current measurement (VS&IM)
- Current source and voltage measurement (IS&VM)
- Voltage source (VS)
- Current source (IS)
- Voltmeter (VM)
- Ammeter (IM)
- Resistance meter (IS&VM)

These functions can be selected for each channel to form an arbitrary combination of functions.

Allows voltage sensing of a two-wire system or four-wire system by switching between local sense and remote sense.

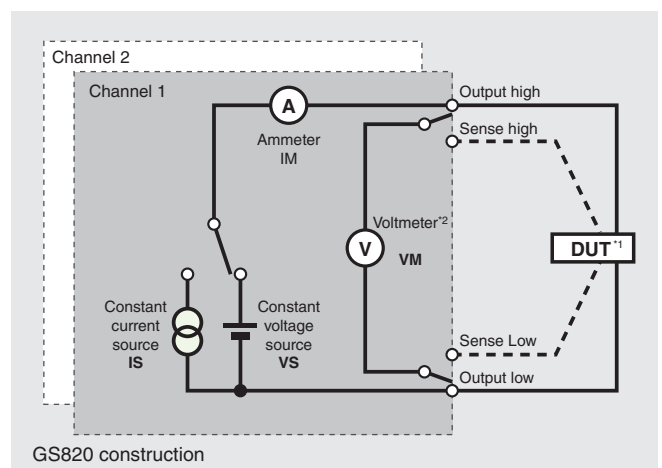

*1: Device Under Test
 *2: For DUT voltage measurement
 - - - Used to measure a four-wire system

Combination of Source and Measurement Functions (example)

The combination of the source and measurement functions of two channels allows for the testing of various DUTs.

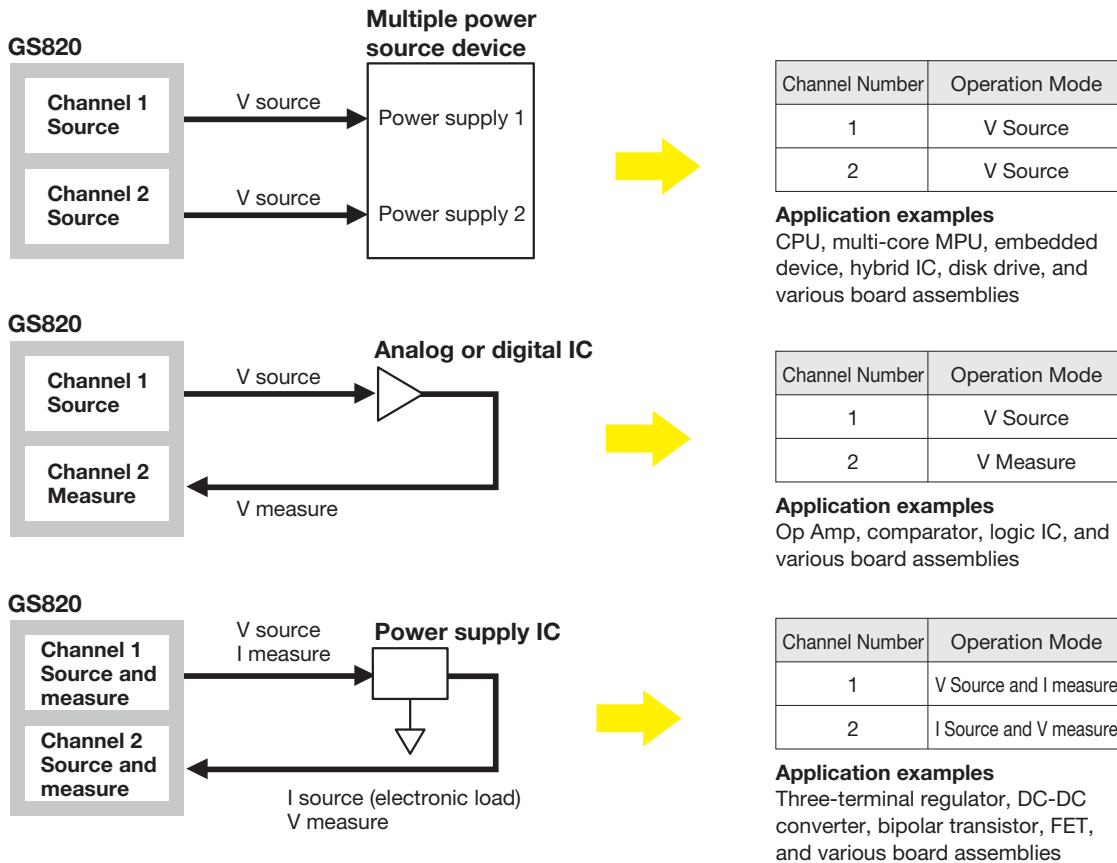

Zero Generation Function of Voltage and Current (Fast load disconnection without chattering)

The zero generation of the GS820 generates zero voltage or current, and controls the current/voltage limiter to limit the load current. The GS820 stops applying the voltage or supplying the current to the load in zero generation state, allowing the DUT to be disconnected with the output relay turned ON. This function avoids the problems of chattering, as well as contact life of the output relay, and also reduces the time for turning ON/OFF the output.

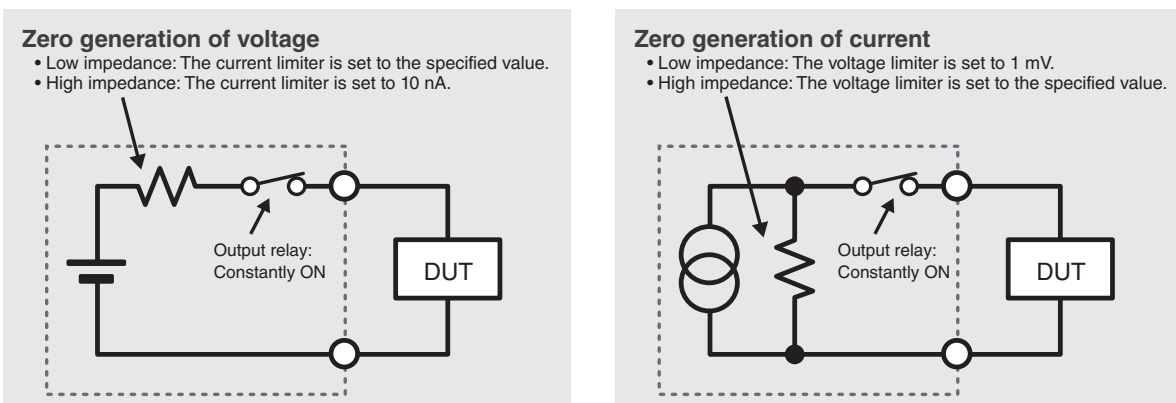

Source and Measurement Timing

Basic Source Measurement Timing

5

The GS820 performs generation and measurement using its internal timer or a trigger input such as an external input signal. When a trigger signal is received, the GS820 starts generating a signal after the source delay time elapses and carries out a measurement after the measure delay time elapses over a given integration time. The measurement integration time can be set in the range of 0.001 PLC to 25 PLC.² Additionally, the GS820 provides an auto zero measurement function, which measures the internal zero reference after the measurement and performs offset correction in real-time. The integration time of the auto zero measurement is equal to the measurement integration time setting.

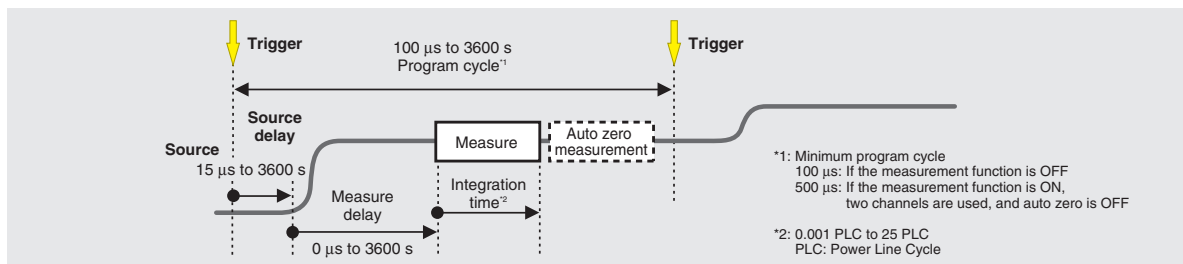

Timing Settings Using Various Trigger Sources

The GS820 allows the generation trigger source and measurement trigger source to be set separately. There are two types of constant period timers and an external signal input that can be used for the generation trigger source. In addition to these sources, source change point and sweep end point can be used for the measurement trigger source. Because the source trigger and measurement trigger can be set separately and also separately for each channel, source and measurement under various connection conditions and timing combinations can be accommodated. There is also an auxiliary trigger that can be activated using an external signal or a program event. The source delay, measure delay, and integration time can be set separately for each channel.

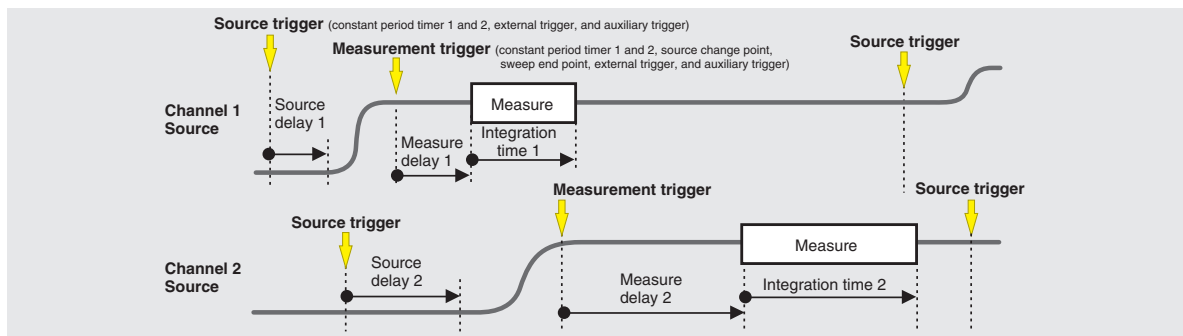

Asynchronous Operation of Source and Measurement

The various trigger sources available on the GS820 allow the source and measurement to be executed asynchronously. The figure below shows an example in which separate timers are used for the source and measurement to achieve multiple measurements in a source cycle.

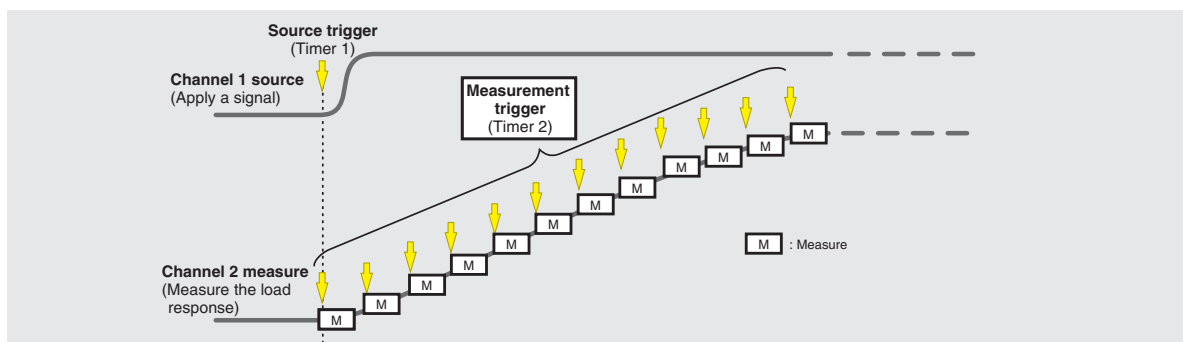

Sweep Function 1: Preset Sweep

The voltage/current generation of the GS820 operates in DC generation mode or pulse generation mode. Each generation mode has preset operation modes such as continuous output, linear sweep, and log sweep that allow the user to perform sweep operations by setting simple parameters. The output level can be changed at a minimum of 100 μ s intervals^{*1} in each sweep mode.

*1: See page 5 for minimum program cycle

Source Mode	Continuous	Linear Sweep	Log Sweep
DC source			
Pulse source			

Sweep Function 2: Arbitrary Waveform Generation of Up to 100000 Points and Simultaneous Sweeping of Control Parameters

In addition to the preset sweep functions described above, the GS820 is equipped with a programmable sweep function that allows the user to define the sweep pattern. A user can create or edit arbitrary waveform data (CSV format) of up to 100000 points using a spreadsheet or text editor. The GS820 is also capable of sweeping the timing and control parameters in addition to the source level. This allows a control sequence that is synchronized to the waveform generation timing. The sweep program can be changed at a minimum of 100 μ s intervals^{*2} in programmable sweep mode.

*2: See page 5 for minimum program cycle

The values do not include the hardware operation time corresponding to the control parameters.

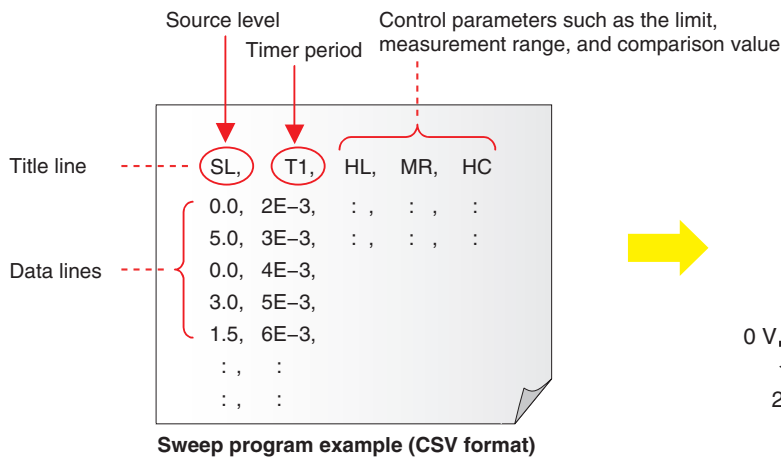

Control parameters that can be included in a sweep program

Title Symbol	Parameter
[CHn.] SF	Source function
↓ SR	Source range
↓ SL	Source level
↓ HL	High limit
↓ LL	Low limit
↓ SD	Source delay
↓ PW	Pulse width
↓ PB	Pulse base
↓ MS	Measure ON/OFF
↓ MF	Measure function
↓ MR	Measure range
↓ MD	Measure delay
↓ HC	Compare high
↓ LC	Compare low

Title Symbol	Parameter
T1	Timer 1 period
T2	Timer 2 period
AT	Auxiliary trigger generation
DO	Digital output

- Write the items you want to define in the title line.
- The items that you can include are source value, limit value, measurement range, comparison value, period, delay, etc.
- A channel can be specified for each item (excluding timer, trigger, and digital output).

* [CHn.]: Specify the channel by setting n = 1 or 2

PC Connectivity

When the GS820 is connected to a PC via the USB, the PC detects the GS820 internal memory as a USB storage device. A pattern file can easily be stored in the GS820 internal memory by creating the GS820 generation pattern on a PC application and dragging and dropping the pattern file. The GS820 sweeps the voltage or current levels according to the generation pattern that is written in this file, measures the load current or load voltage at the appropriate points, and stores the measurement results to the GS820 internal memory. A measurement result file can be retrieved into the PC by dragging and dropping. There is absolutely no complex programming or installation of dedicated software programs required.

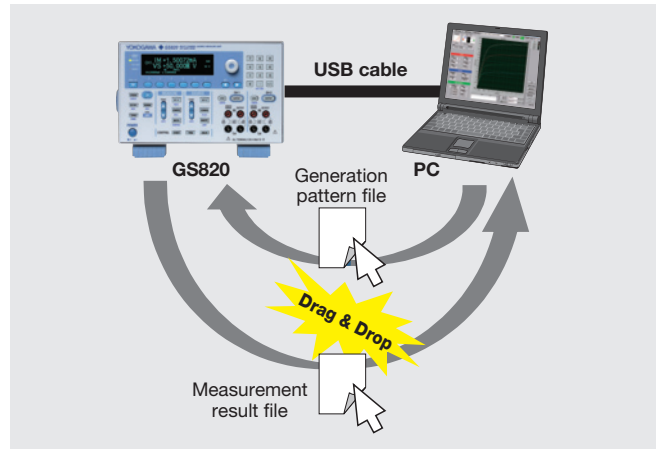

Channel Expansion (Expansion up to 10 channels using the master-slave operation)

Multiple GS820s can be connected as shown below and used as a multi-channel source measure unit. The master-slave feature allows the program data of all connected channels to be set and collected by simply accessing the master unit. The master unit ① distributes the source data to the slave units or ② collects and merges the measured data of all slave units. Complete synchronization of all channels can be achieved by connecting the exclusive trigger signal line.

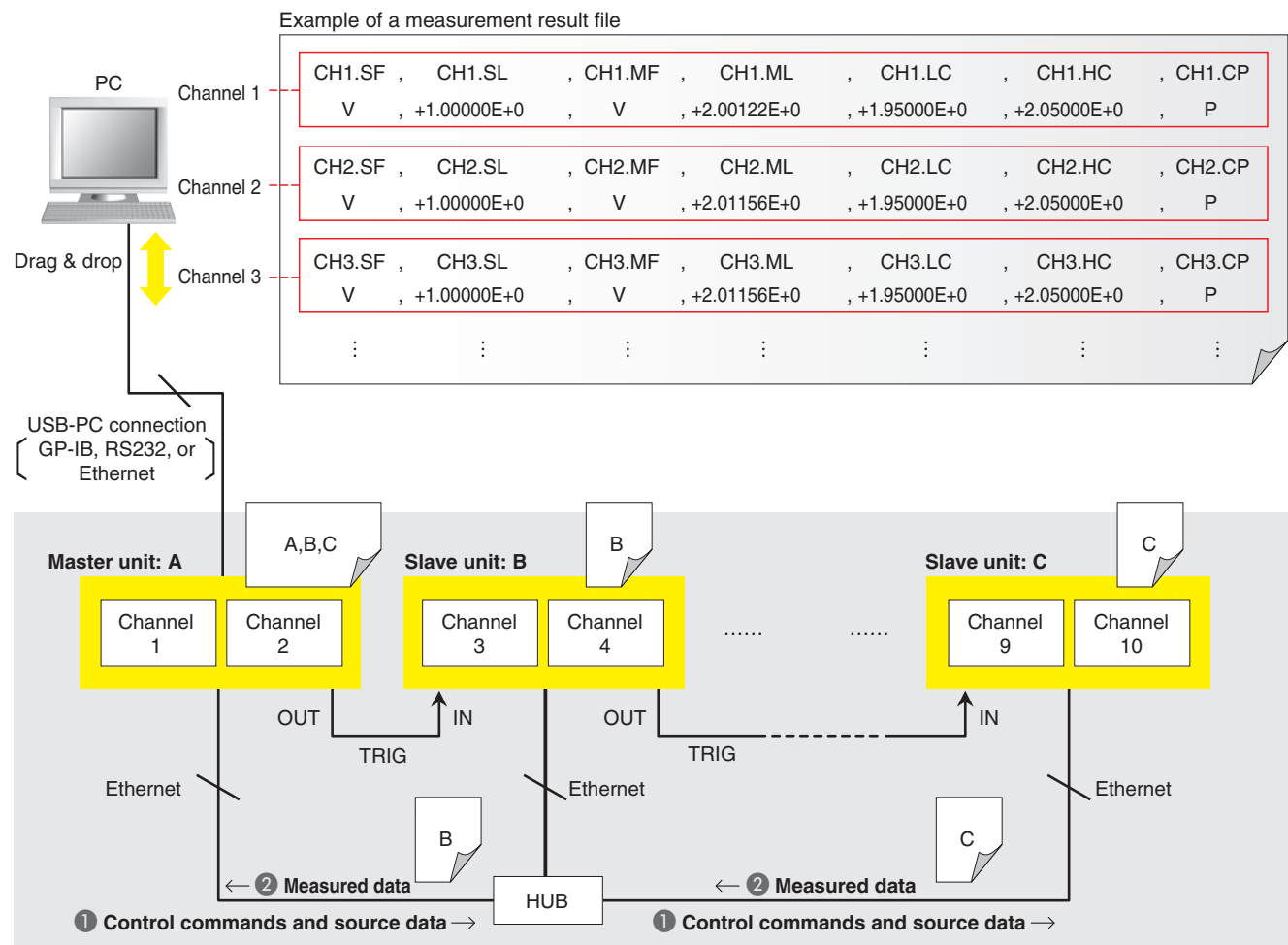

This feature cannot be used when mixed with 18 V model and 50 V model.

Application

Tests for LED lighting (I/V curve trace)

The LED module is consisted by series connected LEDs and the varistor. The GS820 50 V range model 765611/12 can generate voltage up to 50 V. This supports varistor test by using I/V characteristics curve tracing and it also can measure the LED characteristics.

9

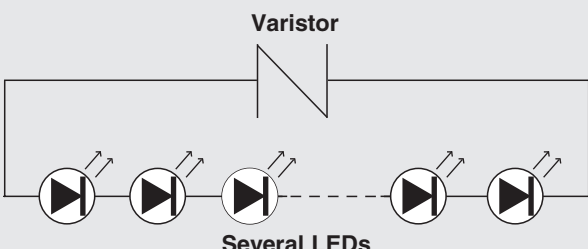

Several LEDs
The principle of LED module

Features

- Voltage generation up to 50 V
- 2 modes of VS/IM and IS/VM
- Extremely small current measurement at 200 nA range and 1 pA resolution
- Curve trace function using voltage/current sweep
- Output measured data in CSV format
- Easy access to the internal USB memory
- No dedicated software required

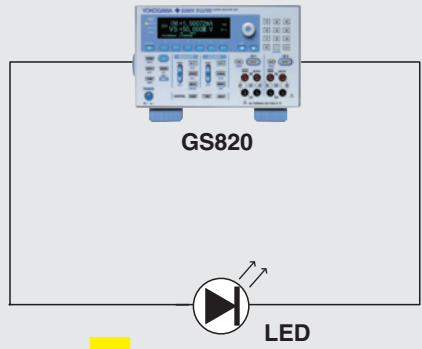

GS820

LED

I/V curve trace

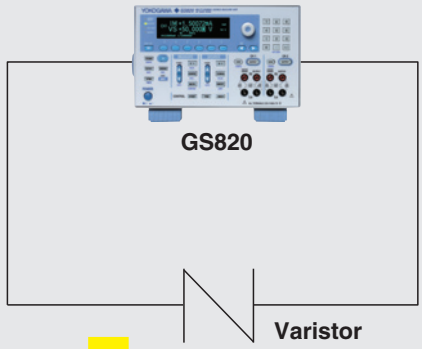

GS820

Varistor

I/V curve trace

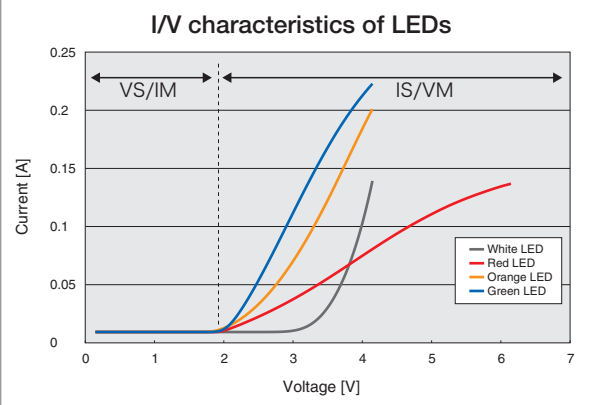

I/V characteristics of LEDs

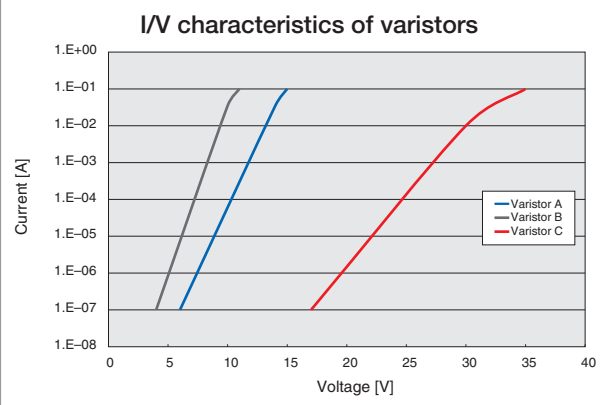

I/V characteristics of varistors

Measurement of the Static Characteristics of Three-Terminal Semiconductor Devices (Transistors, FETs, etc.) (Semiconductor parametric test)

The GS820 can measure drain current I_D by applying gate-source voltage V_{GS} from channel 1 and drain-source voltage V_{DS} from channel 2.

Channel 1 V source V_{GS}

Channel 2 V source I measurement V_{DS}

GS820

Id

Features

- Voltage application and current measurement using two synchronized channels
- Small current measurement at 200 nA range and 1 pA resolution
- Curve trace function using voltage/current sweep
- Output measured data in CSV format
- Easy access to the internal USB memory
- No dedicated software required

Measurement data file

CH1.Vgs(V)	CH2.Id(A)
0.00E+00	8.87E-03
-2.00E-02	8.46E-03
-4.00E-02	8.05E-03
-6.00E-02	7.65E-03
-8.00E-02	7.26E-03
-1.00E-01	6.87E-03
-1.20E-01	6.49E-03
-1.40E-01	6.12E-03
-1.60E-01	5.76E-03

(data edited in the spreadsheet)

Graph

Id-Vgs

Drain current (A)

Gate-source voltage V_{GS} (V)

Timing Tests at Power-On of Multiple Power Supplies (Programmable arbitrary waveform generation)

The GS820 can generate different supply voltages from the two channels to drive a multiple power source device. The transient changes in the source voltage can be programmed by entering values in a general-purpose spreadsheet.

Features

- Synchronized output of two power supplies
- Maximum output current of $3.2 \text{ A} \times 2$ channels
- Easy voltage programming
- No dedicated software required

Startup waveform of multiple power supplies

Supply voltage (V)

Time (s)

— 1.4 V power (V) — 3.3 V power (V)

Timing at Power-On (Source Data)

Source data file

1.4-V power supply (V)	3.3-V power supply (V)
0.00	0.00
0.01	0.02
0.02	0.04
0.03	0.06
0.04	0.08
0.05	0.10
0.06	0.12
0.07	0.14
0.08	0.16
0.09	0.18
0.10	0.20
0.11	0.22
0.12	0.24

Digital Oscilloscope

Signal analysis

Microprocessor

3.3 V (I/O voltage)

1.4 V (internal voltage)

Channel 1 V source

Channel 2 V source

GS820

Measurement of I/O Characteristics of Semiconductor Devices (DC voltage/current reference)

The GS820 is used to apply voltage V_i to the gate input of a logic IC from channel 1 and measure gate output voltage V_o on channel 2. The source and measure channels allow the I/O characteristics of the gate to be measured.

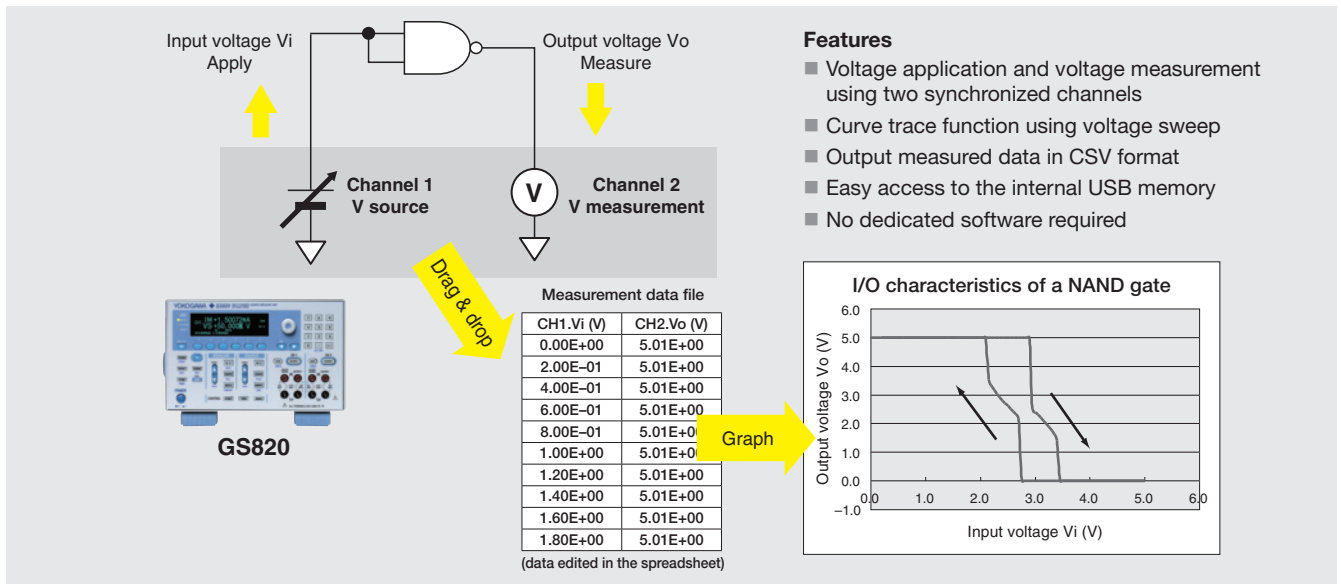

Features

- Voltage application and voltage measurement using two synchronized channels
- Curve trace function using voltage sweep
- Output measured data in CSV format
- Easy access to the internal USB memory
- No dedicated software required

Measurement data file	
CH1.Vi (V)	CH2.Vo (V)
0.00E+00	5.01E+00
2.00E-01	5.01E+00
4.00E-01	5.01E+00
6.00E-01	5.01E+00
8.00E-01	5.01E+00
1.00E+00	5.01E+00
1.20E+00	5.01E+00
1.40E+00	5.01E+00
1.60E+00	5.01E+00
1.80E+00	5.01E+00

(data edited in the spreadsheet)

I/O characteristics of a NAND gate

Output voltage V_o (V)

Input voltage V_i (V)

Power Conversion Efficiency Measurement of Power Supply ICs (Electronic load, DC voltage/current reference)

The GS820 can measure the power conversion efficiency of a three-terminal regulator or a DC-DC converter. A channel for supplying power is connected to the primary circuit and another channel for consuming power is connected to the secondary circuit. Then, the load current is swept to vary the consumed power and supplied power. The power conversion efficiency is determined from the ratio of the consumed power to the supplied power.

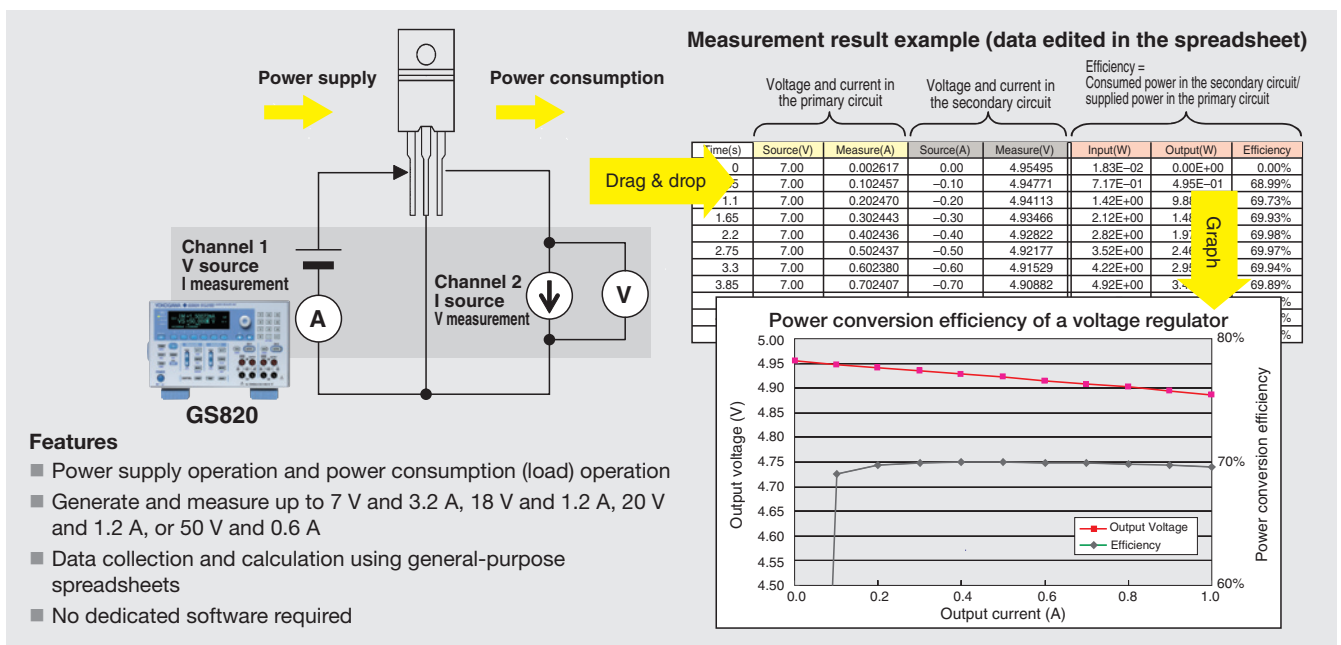

Measurement result example (data edited in the spreadsheet)

Time(s)	Voltage and current in the primary circuit		Voltage and current in the secondary circuit		Efficiency = Consumed power in the secondary circuit / supplied power in the primary circuit		
	Source(V)	Measure(A)	Source(A)	Measure(V)	Input(W)	Output(W)	Efficiency
0	7.00	0.002617	0.00	4.95495	1.83E-02	0.00E+00	0.00%
0.5	7.00	0.102457	-0.10	4.94771	7.17E-01	4.95E-01	68.99%
1.1	7.00	0.202470	-0.20	4.94113	1.42E+00	9.81E-01	69.73%
1.65	7.00	0.302443	-0.30	4.93466	2.12E+00	1.44E+00	69.93%
2.2	7.00	0.402436	-0.40	4.92822	2.82E+00	1.91E+00	69.98%
2.75	7.00	0.502437	-0.50	4.92177	3.52E+00	2.44E+00	69.97%
3.3	7.00	0.602380	-0.60	4.91529	4.22E+00	2.93E+00	69.94%
3.85	7.00	0.702407	-0.70	4.90882	4.92E+00	3.41E+00	69.89%

Power conversion efficiency of a voltage regulator

Output voltage (V)

Output current (A)

Power conversion efficiency (%)

Features

- Power supply operation and power consumption (load) operation
- Generate and measure up to 7 V and 3.2 A, 18 V and 1.2 A, 20 V and 1.2 A, or 50 V and 0.6 A
- Data collection and calculation using general-purpose spreadsheets
- No dedicated software required

765670 Curve Tracer Software

Product Overview

This product is a high-speed, high-accuracy real-time I/V curve tracer that consists of the GS series Source Measure Unit and the 765670 Curve Tracer Software. It is particularly well-suited to DC parametric tests of small signals.

Simple system configuration, easy connection, compact, and light

This system is configured by connecting the GS series Source Measure Unit to a PC that contains the 765670 Curve Tracer Software via USB. You can perform high-speed, high-accuracy curve tracing despite its compact size, light weight, and simple system configuration.

Real-time, High-Speed Drawing

The GS series is high-speed communication and sweep features allow high-speed graph update rate up to 20 pages/s (GS820). You can use the real-time curve tracer with comfort.

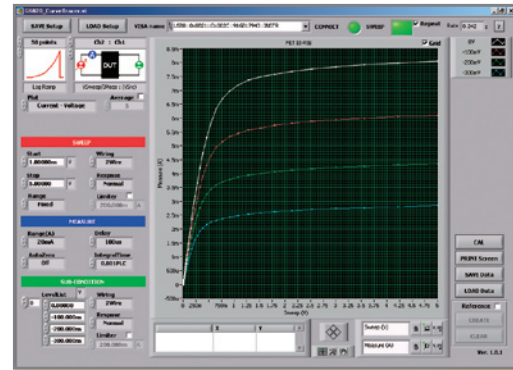

12

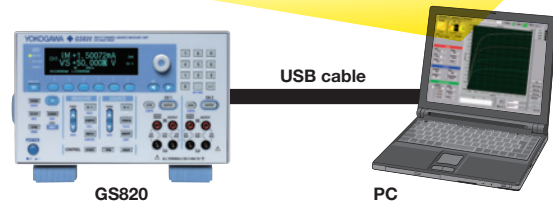

Rear panel

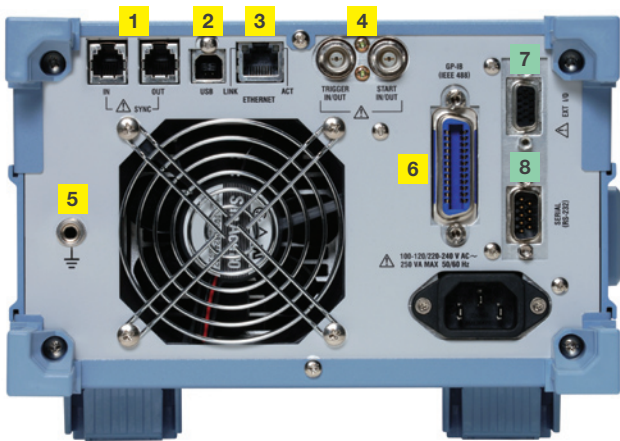

765601/765611

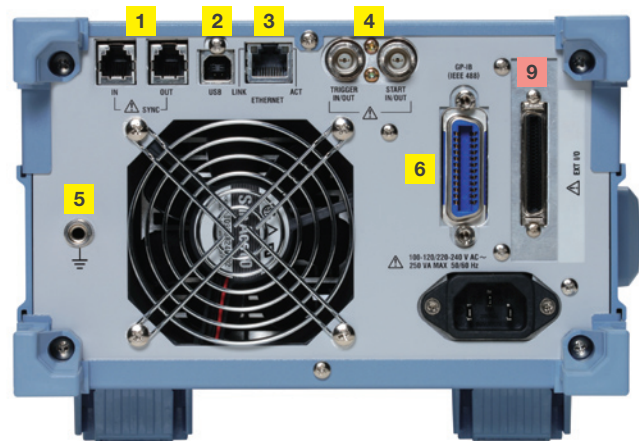

765602/765612

- 1** I/O terminals for synchronized operation
- 2** USB port
- 3** Ethernet port
- 4** BNC I/O terminals
- 5** Functional ground terminal

- 6** GP-IB connector
- 7** Digital I/O connector (15 pins)
- 8** RS-232 connector
- 9** Digital I/O connector (50 pins)

Source Section

18 V Range Model (765601/765602)

DC Voltage Source

Range	Source Range	Resolution	Max. Load Current	Accuracy (One Year) ±(% of setting + V)	Temperature Coefficient ±(% of setting + V)/°C
200 mV	±200.000 mV	1 µV	±3.2 A	0.02 + 250 µV	0.003 + 35 µV
2 V	±2.00000 V	10 µV	±3.2 A	0.02 + 400 µV	0.003 + 60 µV
7 V	±7.0000 V	100 µV	±3.2 A	0.02 + 2 mV	0.003 + 300 µV
18 V	±18.0000 V	100 µV	±1.2 A	0.02 + 2 mV	0.003 + 300 µV

Output resistance (for four-wire system remote sensing)
 • 200 mV, 2 V range: (Shunt resistance/40000) Ω or less
 • 7 V, 18 V range: (Shunt resistance/5000) Ω or less

DC Current Source

Range	Source Range	Resolution	Max. Load Voltage	Accuracy (One Year) ±(% of setting + A)	Temperature Coefficient ±(% of setting + A)/°C
200 nA	±200.000 nA	1 pA	±18 V	0.06 + 3 nA	500 pA
2 µA	±2.00000 µA	10 pA	±18 V	0.04 + 3 nA	500 pA
20 µA	±20.0000 µA	100 pA	±18 V	0.03 + 3 nA	0.0045 + 450 pA
200 µA	±200.000 µA	1 nA	±18 V	0.03 + 30 nA	0.0045 + 4.5 nA
2 mA	±2.00000 mA	10 nA	±18 V	0.03 + 250 nA	0.0045 + 37.5 nA
20 mA	±20.0000 mA	100 nA	±18 V	0.03 + 2.5 µA	0.0045 + 375 nA
200 mA	±200.000 mA	1 µA	±18 V	0.03 + 25 µA	0.0045 + 3.75 µA
1 A	±1.20000 A	10 µA	±18 V	0.05 + 900 µA	0.0075 + 135 µA
3 A	±3.20000 A	10 µA	±7 V	0.05 + 1.5 mA	0.0075 + 225 µA

Output resistance
 • 1 A, 3 A range: 10 kΩ or greater
 • 20 µA to 200 mA range: (Shunt resistance × 50000) Ω or greater
 • 200 nA, 2 µA range: 10 GΩ or greater

One year accuracy for 23±5°C
 Add the tempco for 5 to 18°C and 28 to 40°C

50 V Range Model (765611/765612)

DC Voltage Source

Range	Source Range	Resolution	Max. Load Current	Accuracy (One Year) ±(% of setting + V)	Temperature Coefficient ±(% of setting + V)/°C
200 mV	±200.000 mV	1 µV	±1.2 A	0.02 + 250 µV	0.003 + 35 µV
2 V	±2.00000 V	10 µV	±1.2 A	0.02 + 400 µV	0.003 + 60 µV
20 V	±20.0000 V	100 µV	±1.2 A	0.02 + 8 mV	0.003 + 300 µV
50 V	±50.0000 V	100 µV	±0.6 A	0.02 + 20 mV	0.003 + 3 mV

Output resistance (for four-wire system remote sensing)
 • 200 mV, 2 V range: (Shunt resistance/40000) Ω or less
 • 20 V, 50 V range: (Shunt resistance/2000) Ω or less

DC Current Source

Range	Source Range	Resolution	Max. Load Voltage	Accuracy (One Year) ±(% of setting + A)	Temperature Coefficient ±(% of setting + A)/°C
200 nA	±200.000 nA	1 pA	±50 V	0.06 + 3 nA	500 pA
2 µA	±2.00000 µA	10 pA	±50 V	0.04 + 3 nA	500 pA
20 µA	±20.0000 µA	100 pA	±50 V	0.03 + 3 nA	0.0045 + 450 pA
200 µA	±200.000 µA	1 nA	±50 V	0.03 + 30 nA	0.0045 + 4.5 nA
2 mA	±2.00000 mA	10 nA	±50 V	0.03 + 250 nA	0.0045 + 37.5 nA
20 mA	±20.0000 mA	100 nA	±50 V	0.03 + 2.5 µA	0.0045 + 375 nA
200 mA	±200.000 mA	1 µA	±50 V	0.03 + 25 µA	0.0045 + 3.75 µA
0.5 A	±0.60000 A	10 µA	±50 V	0.06 + 900 µA	0.0075 + 135 µA
1.0 A	±1.20000 A	10 µA	±20 V	0.06 + 1.5 mA	0.0075 + 135 µA

Output resistance
 • 0.5 A, 1 A range: 10 kΩ or greater
 • 20 µA to 200 mA range: (Shunt resistance × 50000) Ω or greater
 • 200 nA, 2 µA range: 10 GΩ or greater

Shunt resistance: See "DC Current Measurement"

One year accuracy for 23±5°C
 Add the tempco for 5 to 18°C and 28 to 40°C

18 V/50 V Range Models

Current Limiter

[Setting] ^{*1}	Range	Resolution	Min. Setting
10.000 nA to 200.000 nA	200 nA	1 pA	10 nA
0.20001 µA to 2.00000 µA	2 µA	10 pA	10 nA
2.0001 µA to 20.0000 µA	20 µA	100 pA	100 nA
20.001 µA to 200.000 µA	200 µA	1 nA	1 µA
200.01 µA to 2.00000 mA	2 mA	10 nA	10 µA
2.0001 mA to 20.0000 mA	20 mA	100 nA	100 µA
20.001 mA to 200.000 mA	200 mA	1 µA	1 mA
0.20001 A to 1.20000 A	1 A	10 µA	10 mA
1.20001 A to 3.20000 A	3 A	10 µA	10 mA

Response Time (Typical)

	18 V model	50 V model
Voltage Source	200 mV range	250 µs
	2 V range	50 µs
	7 V, 18 V range	100 µs
	20 V range	—
	50 V range	—
Current Source	200 nA range	250 ms
	2 µA range	25 ms
	20 µA range	2.5 ms
	200 µA range	250 µs
	2 mA range	250 µs
	20 mA to 1 A range	80 µs
3 A range	80 µs	

In normal mode. The time for the output to reach within 0.1% of the final value after the output starts changing. Pure resistive load. The limiter setting is at the full scale of the range. Source voltage or current is at the maximum value of the range. Source voltage is at the maximum load current, and source current is at the load voltage 2 V.

Voltage Limiter

[Setting] ^{*1}	18 V model Range	50 V model Range	Resolution	Min. Setting
1.000 mV to 200.000 mV	200 mV	200 mV	1 µV	1 mV
0.20001 V to 2.00000 V	2 V	2 V	10 µV	1 mV
2.0001 V to 7.0000 V	7 V	20 V	100 µV	5 mV
7.0001 V to 18.0000 V	18 V	20 V	100 µV	5 mV
18.0001 V to 20.0000 V	—	20 V	100 µV	5 mV
20.0001 V to 50.0000 V	—	50 V	100 µV	50 mV

*1: Larger of the two values [high limit value] or [low limit value] when tracking is OFF

LC Load

Current Source/ Measurement/Limiter Range	Normal Mode		Stable Mode	
	Max. C load	Max. L load	Max. C load	Max. L load
200 nA to 2 mA	0.01 µF			
20 mA	0.1 µF	10 µH	100 µF	1 mH
200 mA	1 µF			
0.5 A to 3 A	10 µF			

Output Noise (Typical)

20 mVp-p (18 V model), 100 mVp-p (50 V model)
 For DC to 20 MHz, 2 V voltage source range, and 1 A current limiter range

Measurement Section

18 V Range Model (765601/765602)

DC Voltage Measurement

Range	Measurement Range	Resolution	Accuracy ±(% of reading + V)	Temperature Coefficient ±(% of reading + V)/°C
200 mV	±210.000 mV	1 µV	0.015 + 200 µV (250 µV) { 300 µV } [500 µV]	0.0025 + 30 µV (40 µV) { 45 µV } [60 µV]
2 V	±2.10000 V	10 µV	0.015 + 200 µV (400 µV) { 1 mV } [5 mV]	0.0025 + 30 µV (60 µV) { 200 µV } [800 µV]
7 V	± 7.1000 V	100 µV	0.015 + 2 mV (4 mV) { 10 mV } [50 mV]	0.0025 + 300 µV (600 µV) { 2 mV } [8 mV]
18 V	±18.0000 V	100 µV	0.015 + 2 mV (4 mV) { 10 mV } [50 mV]	0.0025 + 300 µV (600 µV) { 2 mV } [8 mV]

14

DC Current Measurement

Range	Measurement Range	Resolution	Shunt Resistance	Accuracy ±(% of reading + A)	Temperature Coefficient ±(% of reading + A)/°C
200 nA	±210.000 nA	1 pA	1 MΩ	0.05 + 3 nA (3 nA) { 3 nA } [4 nA]	500 pA (500 pA) { 500 pA } [600 pA]
2 µA	±2.10000 µA	10 pA	1 MΩ	0.025 + 3 nA (3 nA) { 4 nA } [6 nA]	500 pA (500 pA) { 500 pA } [600 pA]
20 µA	±21.0000 µA	100 pA	100 kΩ	0.025 + 4 nA (6 nA) { 10 nA } [50 nA]	0.004 + 600 pA (900 pA) { 1.5 nA } [8 nA]
200 µA	±210.000 µA	1 nA	10 kΩ	0.02 + 40 nA (60 nA) { 100 nA } [500 nA]	0.003 + 6 nA (9 nA) { 15 nA } [80 nA]
2 mA	±2.10000 mA	10 nA	1 kΩ	0.02 + 400 nA (600 nA) { 1 µA } [5 µA]	0.003 + 60 nA (90 nA) { 150 nA } [800 nA]
20 mA	±21.0000 mA	100 nA	100 Ω	0.02 + 4 µA (6 µA) { 10 µA } [50 µA]	0.003 + 600 nA (900 nA) { 1.5 µA } [8 µA]
200 mA	±210.000 mA	1 µA	10 Ω	0.02 + 70 µA (100 µA) { 150 µA } [500 µA]	0.003 + 10 µA (15 µA) { 20 µA } [80 µA]
1 A	±1.30000 A	10 µA	1 Ω	0.03 + 700 µA (1 mA) { 2 mA } [6 mA]	0.0045 + 100 µA (150 µA) { 300 µA } [900 µA]
3 A	±3.20000 A	10 µA	1 Ω	0.05 + 1 mA (1.5 mA) { 2 mA } [6 mA]	0.0075 + 150 µA (200 µA) { 300 µA } [900 µA]

50 V Range Model (765611/765612)

DC Voltage Measurement

Range	Measurement Range	Resolution	Accuracy ±(% of reading + V)	Temperature Coefficient ±(% of reading + V)/°C
200 mV	±210.000 mV	1 µV	0.015 + 200 µV (250 µV) { 300 µV } [500 µV]	0.0025 + 30 µV (40 µV) { 45 µV } [60 µV]
2 V	±2.10000 V	10 µV	0.015 + 200 µV (400 µV) { 1 mV } [5 mV]	0.0025 + 30 µV (60 µV) { 200 µV } [800 µV]
20 V	±21.0000 V	100 µV	0.015 + 8 mV (16 mV) { 40 mV } [200 mV]	0.0025 + 300 µV (600 µV) { 2 mV } [8 mV]
50 V	±50.1000 V	100 µV	0.015 + 20 mV (40 mV) { 100 mV } [500 mV]	0.0025 + 3 mV (6 mV) { 20 mV } [80 mV]

DC Current Measurement

Range	Measurement Range	Resolution	Shunt Resistance	Accuracy ±(% of reading + A)	Temperature Coefficient ±(% of reading + A)/°C
200 nA	±210.000 nA	1 pA	1 MΩ	0.05 + 3 nA (3 nA) { 3 nA } [4 nA]	500 pA (500 pA) { 500 pA } [600 pA]
2 µA	±2.10000 µA	10 pA	1 MΩ	0.025 + 3 nA (3 nA) { 4 nA } [6 nA]	500 pA (500 pA) { 500 pA } [600 pA]
20 µA	±21.0000 µA	100 pA	100 kΩ	0.025 + 4 nA (6 nA) { 10 nA } [50 nA]	0.004 + 600 pA (900 pA) { 1.5 nA } [8 nA]
200 µA	±210.000 µA	1 nA	10 kΩ	0.02 + 40 nA (60 nA) { 100 nA } [500 nA]	0.003 + 6 nA (9 nA) { 15 nA } [80 nA]
2 mA	±2.10000 mA	10 nA	1 kΩ	0.02 + 400 nA (600 nA) { 1 µA } [5 µA]	0.003 + 60 nA (90 nA) { 150 nA } [800 nA]
20 mA	±21.0000 mA	100 nA	100 Ω	0.02 + 4 µA (6 µA) { 10 µA } [50 µA]	0.003 + 600 nA (900 nA) { 1.5 µA } [8 µA]
200 mA	±210.000 mA	1 µA	10 Ω	0.02 + 70 µA (100 µA) { 150 µA } [500 µA]	0.003 + 10 µA (15 µA) { 20 µA } [80 µA]
0.5 A	±0.60000 A	10 µA	1 Ω	0.03 + 700 µA (1 mA) { 2 mA } [6 mA]	0.0045 + 100 µA (150 µA) { 300 µA } [900 µA]
1.0 A	±1.20000 A	10 µA	1 Ω	0.05 + 1 mA (1.5 mA) { 2 mA } [6 mA]	0.0075 + 150 µA (200 µA) { 300 µA } [900 µA]

One year accuracy for 23±5°C.

Add the temperature coefficient for 5 to 18°C and 28 to 40°C.

Values inside () are for 0.1 PLC ≤ integration time < 1 PLC. Values inside { } are for 0.01 PLC ≤ integration time < 0.1 PLC.

Values inside [] are for 0.001 PLC ≤ integration time < 0.01 PLC.

Functions

Source	
Function	Voltage or current
Mode	DC or pulse (pulse width: 50 μ s to 3600 s)
Sweep mode	Linear, logarithmic, or program (up to 100000 steps)
Trigger source	External or internal timers 1 and 2 (period: 100 μ s to 3600 s)
Sweep start source	External or internal timers 1 and 2 (period: 100 μ s to 3600 s)
Source delay	15 μ s to 3600 s
Response characteristics	Normal or stable

Measurement	
Function	Voltage, current, auto, voltmeter mode, ammeter mode, or resistance meter mode
Integration time	0.001 to 25 PLC (Power Line Cycle)
Trigger source	External or internal timers 1 and 2 (period: 100 μ s to 3600 s)
Measure delay	0 μ s to 3600 s
Measurement data storage	Up to 100000 data points
Average	Moving average (average count: 2 to 256)
Voltage sense	Two-wire system or four-wire system
Auto zero	Measure the internal zero reference every measurement and correct the measured value
NULL computation	Computes the difference with respect to the current measured value or user-defined value
User-defined computation	Computes user-defined equations in real-time
Operators	+ [addition], - [subtraction], * [multiplication], / [division], ^ [exponentiation], % [mod], [logic OR], & [logic AND], ! [negation], < <= > >= == != [comparison], = [substitution]
Functions	ABS() [absolute value], SQRT() [square root], LN(), LOG() [logarithm], SIN(), COS(), TAN() [trigonometric functions], ASIN(), ACOS(), ATAN() [inverse trigonometric functions], SINH(), COSH(), TANH() [hyperbolic functions], RAND() [random number generation], EDGE() [logic change extraction], TRUNC(), FLOOR() [rounding to an integer], ISINF() [infinity judgment], ISNAN [not-a-number judgment]
Conditional statement	IF-THEN-ELSE

External I/O

BNC I/O	
Connector type	BNC connector
I/O level	TTL
I/O logic format	Negative logic, falling edge
Minimum pulse width	10 μ s

Digital I/O	
Connector type	D-Sub 15-pin (model 765601/11) Half-pitch 50-pin (model 765602/12)
I/O level	TTL
Minimum pulse width	10 μ s
Signal Name	Channel 1 Comparison end Channel 1 Comparison result low Channel 1 Comparison result in Channel 1 Comparison result high Channel 2 Comparison end Channel 2 Comparison result low Channel 2 Comparison result in Channel 2 Comparison result high Digital Out 0 and 1 Digital Out 2 to 15* Digital In 0 and 1 Digital In 2 to 15* Interlock input

* Digital Out 2 to 15 and Digital In 2 to 15 are available on 765602 or 765612

I/O for Synchronized Operation		
Connector type	RJ-11 connector BNC connector (select the signal to be assigned to the input and output, separately)	
I/O level	TTL	
Minimum pulse width	10 μ s	
I/O signal for synchronized operation		
Pin No.	Sync Input Connector	Sync Output Connector
1	Output relay control input	Output relay control output
2	Sweep start input	Sweep start output
3	Trigger input	Trigger output
4	GND	GND
5	Auxiliary trigger input	Auxiliary trigger output
6	Zero source control input	Zero source control output

Communication Interface

GPIB	
Electrical and mechanical specifications	Conforms to IEEE St'd 488-1978
Functional specifications	SH1, AH1, T6, L4, SR1, RL1, PPO, DC1, DT1, CO
Protocol	Conforms to IEEE St'd 488.2-1992
Address	0 to 30

RS232	
Connector type	D-Sub 9-pin
Electrical specifications	Conforms to EIA RS232
Connection format	Point-to-point
Transmission mode	Full-duplex
Synchronization mode	Start-stop synchronization
Baud rate	9600, 14400, 19200, 38400, 57600, 115200 bps

USB interface	
Number of ports	1
Connector type	Type B connector (receptacle)
Electrical and mechanical specifications	Conforms to USB Rev. 2.0
Protocol	Mass storage class, USB-TMC

Ethernet	
Number of Ethernet ports	1
Connector type	RJ-45 connector
Electrical and mechanical specifications	Conforms to IEEE 802.3
Transmission system	100BASE-TX/10BASE-T
Data rate	100 Mbps or 10 Mbps
Protocol	VXI-11 server, HTTP server, FTP server, DHCP client, and command socket

General Specifications

Display	256 \times 64 dot VFD
Rated supply voltage	100 to 120 VAC or 200 to 240 VAC
Rated supply frequency	50/60 Hz
Power consumption	Approx. 250 VA
Warm-up time	At least 60 minutes
Operating temperature and humidity range	5°C to 40°C and 20% to 80%RH (no condensation)
Storage temperature and humidity range	-15°C to 60°C and 20% to 80%RH (no condensation)
Max. common-mode voltage	Between the case and each terminal \pm 250 Vpk
Maximum allowable input voltage:	
	Between high sense and low sense \pm 18 Vpk (765601/02)
	Between high sense and low sense \pm 50 Vpk (765611/12)
	Between high output and low output \pm 18 Vpk (765601/02)
	Between high output and low output \pm 50 Vpk (765611/12)
	Between high sense and high output \pm 0.5 Vpk
	Between low sense and low output \pm 0.5 Vpk
	Between each terminal of CH1 and each terminal of CH2 \pm 250 Vpk
External dimensions	Approx. 213 (W) \times 132 (H) \times 450 (D) mm (excluding projections)
Weight	Approx. 8 kg

Model and Suffix code

Model	Suffix Code	Description
765601		GS820 Multi Channel Source Measure Unit 18 V range/2-bit digital I/O model
765602		GS820 Multi Channel Source Measure Unit 18 V range/16-bit digital I/O model
765611		GS820 Multi Channel Source Measure Unit 50 V range/2-bit digital I/O model
765612		GS820 Multi Channel Source Measure Unit 50 V range/16-bit digital I/O model
Power cord	-D	UL/CSA standard, PSE compliant
	-F	VDE standard
	-R	AS standard
	-Q	BS standard
	-H	GB standard
	-N	NBR standard

Standard Accessories

Power cord, rubber feet (4 pieces), measurement leads 758933 (2 sets), small alligator clip adapters 758922 (2 sets), user's manuals (1 set), External I/O connector

Rack Mount Kits

Model	Product	Description
751533-E3	Rack mount kit	EIA standalone installation
751533-J3	Rack mount kit	JIS standalone installation
751534-E3	Rack mount kit	EIA connected installation
751534-J3	Rack mount kit	JIS connected installation

External dimensions

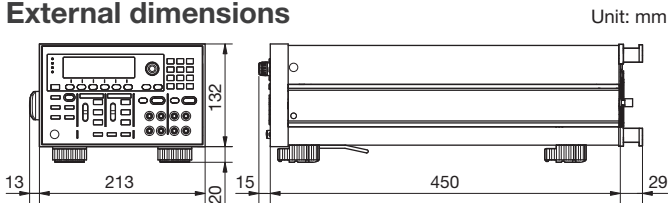

Related product



GS610













Source Measure Unit
Wide-range source and measurement function
Source and measurement range:
±110 V and ±3.2 A



GS200

DC Voltage/Current Source
Highly accurate, highly stable, and low noise
Output range: ±32 V and ±200 mA

Accessories

Model	Name	Description
758933	Measurement lead	1 m safety terminal cable with 2 leads (red and black) in a set 
758917	Measurement lead	0.75 m safety terminal cable with 2 leads (red and black) in a set 
758922 	Small alligator clip adapter	Safety terminal-alligator clip adapter, containing 2 pieces (red and black) in a set 
758929 	Large alligator clip adapter	Safety terminal-alligator clip adapter, containing 2 pieces (red and black) in a set 
758921 	Fork terminal adapter	Safety terminal-fork terminal adapter, containing 2 pieces (red and black) in a set 
758924	Conversion adapter	BNC-binding post adapter 
366924	BNC cable	BNC-BNC cable 1 m 
366925	BNC cable	BNC-BNC cable 2 m 
758923*	Safety terminal adapter	Spring clamp type 2 adapters (red and black) in a set 
758931*	Safety terminal adapter	Screw-in type 2 adapters (red and black) in a set 
758960	Synchronization operation cable	RJ11 6-pin, 1 m

 Due to the nature of this product, it is possible to touch its metal parts. Therefore, there is a risk of electric shock, so the product must be used with caution.

* Wire diameter of cables that can connect to the adapter
758923 Core wire diameter: 2.5 mm or less, covering diameter: 5.0 mm or less
758931 Core wire diameter: 1.8 mm or less, covering diameter: 3.9 mm or less

NOTICE

- Before operating the product, read the user's manual thoroughly for proper and safe operation.

■ Any company's names and product names mentioned in this document are trade names, trademarks or registered trademarks of their respective companies.

Yokogawa's Approach to Preserving the Global Environment

- Yokogawa's electrical products are developed and produced in facilities that have received ISO14001 approval.
- In order to protect the global environment, Yokogawa's electrical products are designed in accordance with Yokogawa's Environmentally Friendly Product Design Guidelines and Product Design Assessment Criteria.

This is a Class A instrument based on Emission standards EN61326-1 and EN55011, and is designed for an industrial environment. Operation of this equipment in a residential area may cause radio interference, in which case users will be responsible for any interference which they cause.

YOKOGAWA

YMI-KS-HMI-SE01

YOKOGAWA METERS & INSTRUMENTS CORPORATION

Global Sales Dept. /Phone: +81-422-52-6237 Facsimile: +81-422-52-6462
E-mail: tm@cs.jp.yokogawa.com

YOKOGAWA CORPORATION OF AMERICA
YOKOGAWA EUROPE B.V.
YOKOGAWA SHANGHAI TRADING CO., LTD.
YOKOGAWA ELECTRIC KOREA CO., LTD.
YOKOGAWA ENGINEERING ASIA PTE. LTD.
YOKOGAWA INDIA LTD.
YOKOGAWA ELECTRIC CIS LTD.
YOKOGAWA AMERICA DO SUL LTDA.
YOKOGAWA AUSTRALIA PTY. LTD.
YOKOGAWA MIDDLE EAST & AFRICA B.S.C(c)

Phone: +1-770-253-7000
Phone: +31-88-4641000
Phone: +86-21-6239-6363
Phone: +82-2-2628-3810
Phone: +65-6241-9933
Phone: +91-80-4158-6000
Phone: +7-495-737-7868
Phone: +55-11-5681-2400
Phone: +61-2-8870-1100
Phone: +973-17-358100

Facsimile: +1-770-254-0928
Facsimile: +31-88-4641111
Facsimile: +86-21-6880-4987
Facsimile: +82-2-2628-3899
Facsimile: +65-6241-2606
Facsimile: +91-80-2852-8656
Facsimile: +7-495-737-7869
Facsimile: +55-11-5681-4434
Facsimile: +61-2-8870-1111
Facsimile: +973-17-336100

Subject to Change without notice.

Copyright © 2007, Yokogawa Electric Corporation
Copyright © 2010, Yokogawa Meters & Instruments Corporation
[Ed: 01/b]

Printed in Japan, 502(KP)

<http://tmi.yokogawa.com/>