

Unit : mm

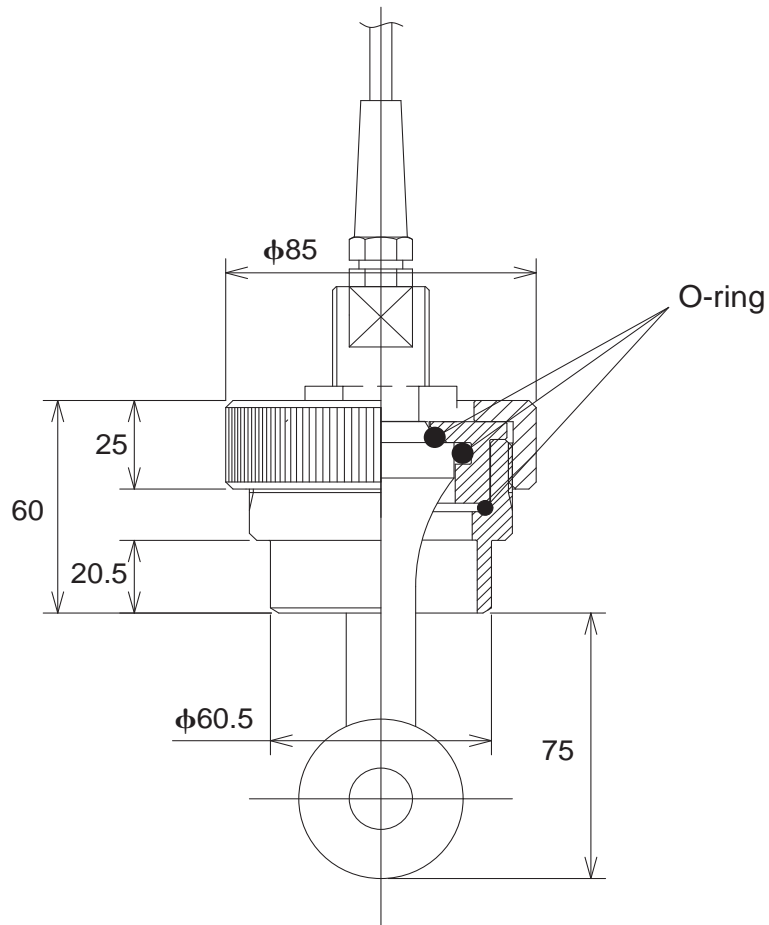

Weight : Approx. 1.2 kg

Unless otherwise specified, differences in the dimensions are specified as : General tolerance=(Criteria of tolerance class IT18 in JIS B0401-1986)/2.